

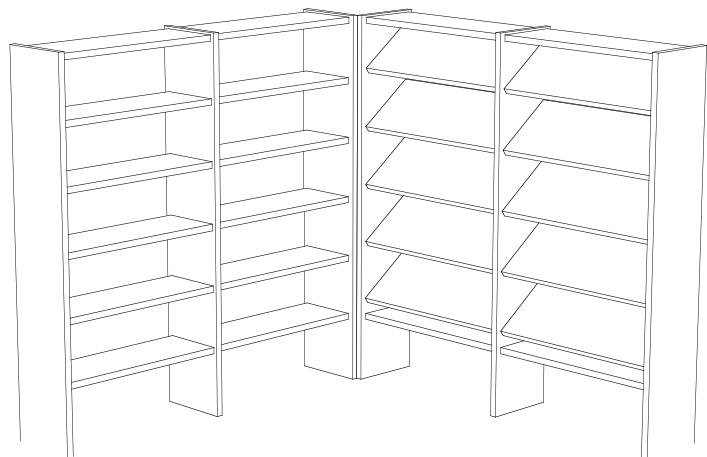

**TECHNICAL SPECIFICATIONS**

# **SOFTLINE SHELVING SYSTEM**



# Softline shelving system

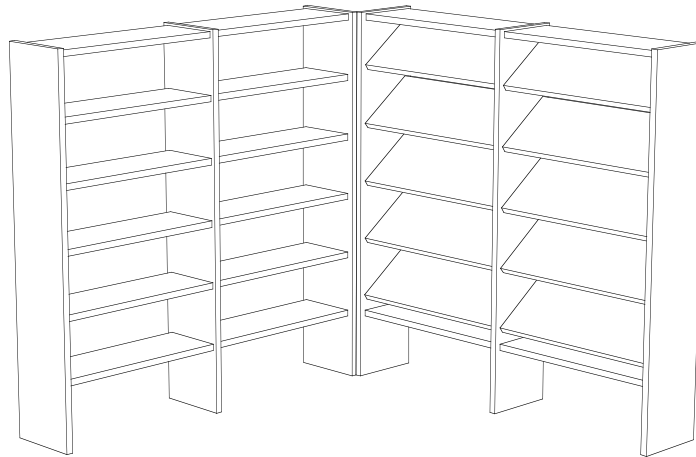

The Softline shelving system, founded in the early 1980's, is flexible and contains many possibilities. It is a starter/add-on system that offers a large selection of standard components specialized for libraries. We are continuously developing new components for this shelving system to meet the demands of modern libraries. The shelving system comes in 5 standard heights, 2 standard widths and 3 shelf depths and as single- or double- sided units. Shelving bays of different heights can be connected; except for height 92 cm. Softline indicates that the upright panel has an ellipse shaped front strip. The upright panels are veneered as standard, which can be stained in a number of colours. The upright panels can also be painted. Softline come with steel shelves with a loose acrylic backstop and rail for hanging book support as standard, but other types of metal shelves and also wooden shelves are optional.

## HEIGHTS

The panels come in five heights;  
92, 122, 152, 182 and 212 cm.  
Heights include adjustable feet (2 cm).  
The shelves are adjustable in 2,5 cm increments.

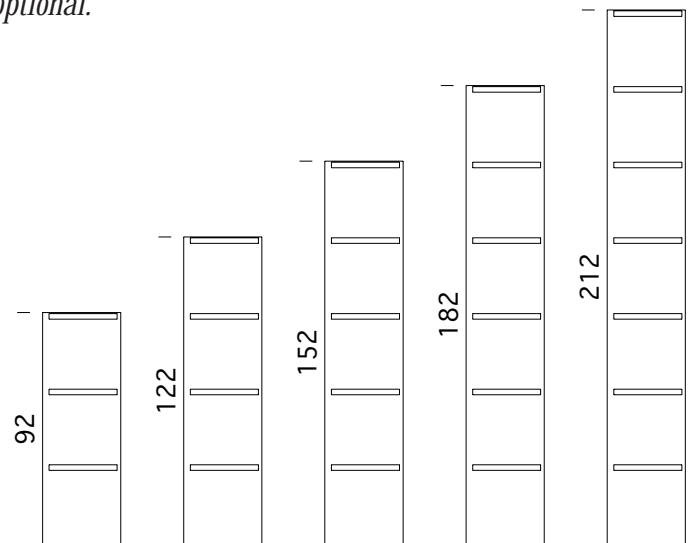

## DEPTHS

The frames come in six depths;  
31 cm for 25 cm deep shelves,  
36 cm for 30 cm deep shelves,  
46 cm for 40 cm deep shelves,  
59 cm for 2x25 cm deep shelves,  
69 cm for 2x30 cm deep shelves,  
89 cm for 2x40 cm deep shelves

Upright panel depth

Steel shelf depth

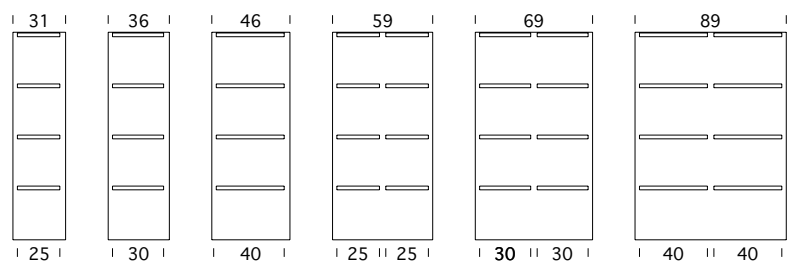

## WIDTHS

The bays are available in starter and add-on bays. A Starter bay has two outside panels while an add-on bay has one middle panel.

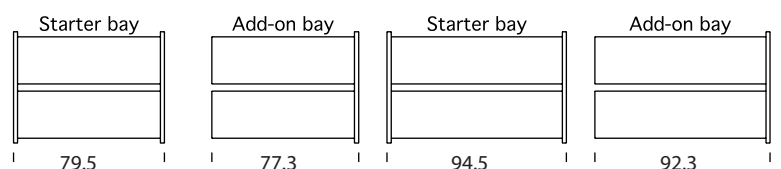

# Softline shelving system

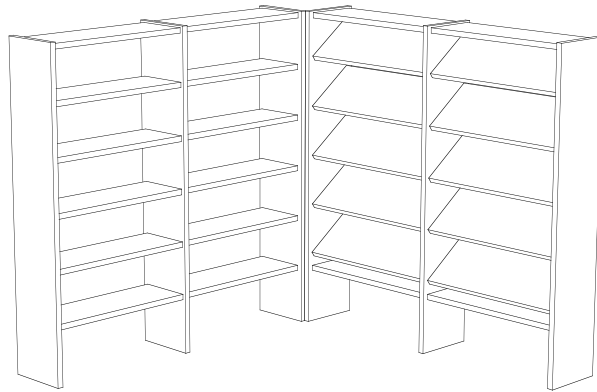

## THE UPRIGHT PANELS

are made of 21 mm thick particleboard of category 1 according to the Swedish standard. The particleboard has a density of 610 kgs per cubic meter and the content of formaldehyde shall not exceed 100 grams dry substance. The particleboard is banded on front vertical edges with a 25 mm thick, super ellipse shaped strip of solid wood. The back edge is banded with a 4 mm flat strip of solid wood. The horizontal edges are banded with a 4 mm flat strip of solid wood. The upright panels are surfaced with 0,6 - 0,8 mm thick wood veneer. One side of each upright panel and both sides of each intermediate panel have rows of 5 mm diameter holes for shelf brackets allowing placement in 25 mm increments. The upright panels have two holes in the bottom for adjustable feet that add 20 mm to the panel height.

Detail of Softline upright panel

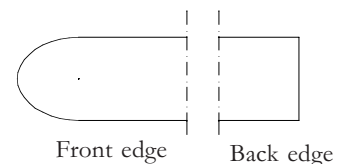

25 mm superelliptical front edge,  
solid beech

4 mm back strip, solid beech

## THE METAL SHELVES

are made of 20-gauge (0,9 mm) sheet steel. The shelves are epoxy painted with a paint thickness of 60 my. The flat steel shelves have a 25 mm high front edge. The sloping steel shelves are bent in a way so they have a stopper to prevent magazines from sliding off. Ordinary flat shelves are 25, 30 and 40 cm deep.

## THE WOOD SHELVES

are made of 21 mm thick lumber core blockboard. The front and back edges are banded with 4 mm thick strips of solid wood. The shelves are surfaced with 0,6-0,8 mm thick wood veneer. The top wood shelves are made of particleboard, so are the writing surfaces, the pull-out shelves and the corner shelves.

## THE METAL FRAMES

are made of 30x20x1,5 mm steel tubes, epoxy painted with a thickness of 60 my.

## THE KICKPLATES

are made of 16 mm thick particleboard. The kickplates are surfaced with 0,6 - 0,8 mm thick wood veneer.

## THE FULL BACKS

are made of 16 mm thick particleboard. They are surfaced with either 0,6 - 0,8 mm thick wood veneer or laminate. The horizontal edges are banded. The vertical edges are not banded, nor are they exposed after assembly of the back panel.

## Softline single-sided bays.

Panel depth 31 cm, shelf depth 25 cm.

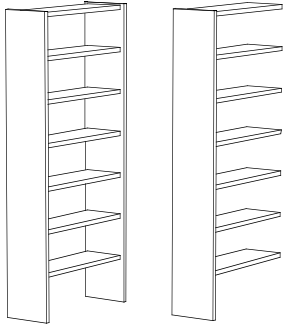
Complete units with panels, shelves, frame and fittings.  
Heights include adjustable feet (2 cm).**Height 212 cm, 6 shelves + top shelf.**Starter bay 75 cm  
Add-on bay 75 cmStarter bay 90 cm  
Add-on bay 90 cm

BB78100127126245

BB78101127126245

BB78100129126245

BB78101129126245

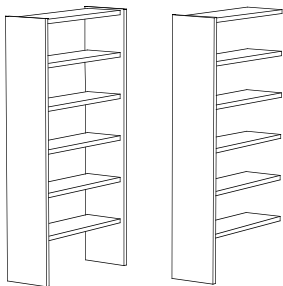
**Height 182 cm, 5 shelves + top shelf.**Starter bay 75 cm  
Add-on bay 75 cmStarter bay 90 cm  
Add-on bay 90 cm

BB78100827125245

BB78101827125245

BB78100829125245

BB78101829125245

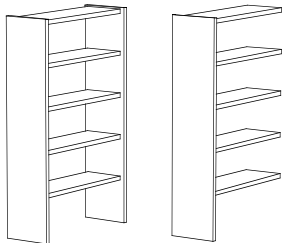
**Height 152 cm, 4 shelves + top shelf.**Starter bay 75 cm  
Add-on bay 75 cmStarter bay 90 cm  
Add-on bay 90 cm

BB78100527124245

BB78101527124245

BB78100529124245

BB78101529124245

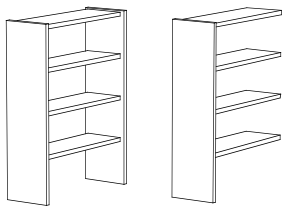
**Height 122 cm, 3 shelves + top shelf.**Starter bay 75 cm  
Add-on bay 75 cmStarter bay 90 cm  
Add-on bay 90 cm

BB78100227123245

BB78101227123245

BB78100229123245

BB78101229123245

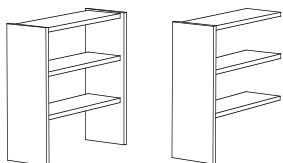
**Height 92 cm, 2 shelves + top shelf.**Starter bay 75 cm  
Add-on bay 75 cmStarter bay 90 cm  
Add-on bay 90 cm

BB78100727222245

BB78101727222245

BB78100729222245

BB78101729222245

Softline single-sided bays.  
**Panel depth 36 cm, shelf depth 30 cm.**

Complete units with panels, steel shelves, frame and fittings.  
 Heights include adjustable feet (2 cm).

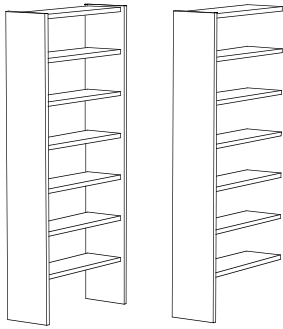

**Height 212 cm, 6 shelves + top shelf.**

Starter bay 75 cm  
 Add-on bay 75 cm

BB78100137126245  
 BB78101137126245

Starter bay 90 cm  
 Add-on bay 90 cm

BB78100139126245  
 BB78101139126245

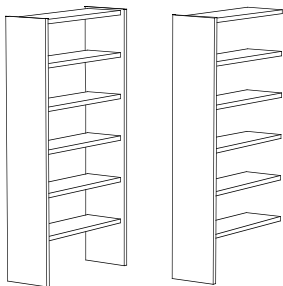

**Height 182 cm, 5 shelves + top shelf.**

Starter bay 75 cm  
 Add-on bay 75 cm

BB78100837125245  
 BB78101837125245

Starter bay 90 cm  
 Add-on bay 90 cm

BB78100839125245  
 BB78101839125245

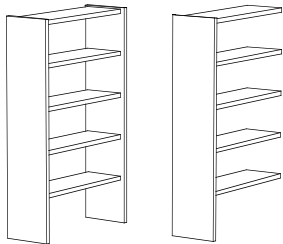

**Height 152 cm, 4 shelves + top shelf.**

Starter bay 75 cm  
 Add-on bay 75 cm

BB78100537124245  
 BB78101537125245

Starter bay 90 cm  
 Add-on bay 90 cm

BB78100539124245  
 BB78101539124245

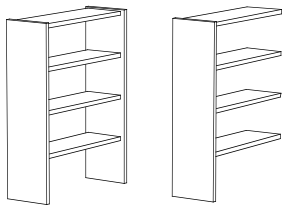

**Height 122 cm, 3 shelves + top shelf.**

Starter bay 75 cm  
 Add-on bay 75 cm

BB78100237123245  
 BB78101237123245

Starter bay 90 cm  
 Add-on bay 90 cm

BB78100239123245  
 BB78101239123245

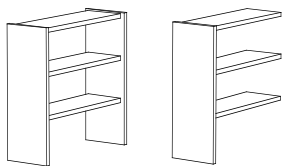

**Height 92 cm, 2 shelves + top shelf.**

Starter bay 75 cm  
 Add-on bay 75 cm

BB78100737122245  
 BB78101737122245

Starter bay 90 cm  
 Add-on bay 90 cm

BB78100739122245  
 BB78101739122245

## Softline single-sided bays.

Panel depth 46 cm, shelf depth 40 cm.

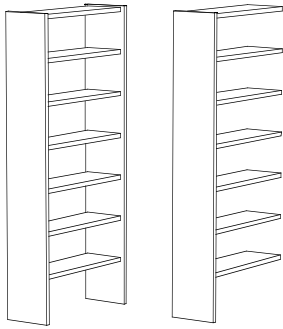
Complete units with panels, steel shelves, frame and fittings.  
Heights include adjustable feet (2 cm).**Height 212 cm, 6 shelves + top shelf.**Starter bay 75 cm  
Add-on bay 75 cmStarter bay 90 cm  
Add-on bay 90 cm

BB78100147126245

BB78101147126245

BB78100149126245

BB78101149126245

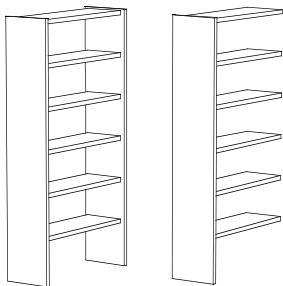
**Height 182 cm, 5 shelves + top shelf.**Starter bay 75 cm  
Add-on bay 75 cmStarter bay 90 cm  
Add-on bay 90 cm

BB78100847125245

BB78101847125245

BB78100849125245

BB78101849125245

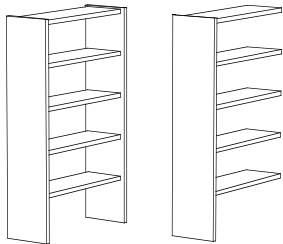
**Height 152 cm, 4 shelves + top shelf.**Starter bay 75 cm  
Add-on bay 75 cmStarter bay 90 cm  
Add-on bay 90 cm

BB78100547124245

BB78101547124245

BB78100549124245

BB78101549124245

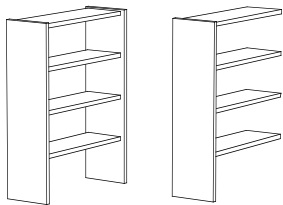
**Height 122 cm, 3 shelves + top shelf.**Starter bay 75 cm  
Add-on bay 75 cmStarter bay 90 cm  
Add-on bay 90 cm

BB78100247123245

BB78101247123245

BB78100249123245

BB78101249123245

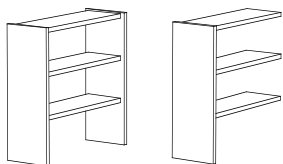
**Height 92 cm, 2 shelves + top shelf.**Starter bay 75 cm  
Add-on bay 75 cmStarter bay 90 cm  
Add-on bay 90 cm

BB78100747122245

BB78101747122245

BB78100749122245

BB78101749122245

Softline double-sided bays.  
**Panel depth 59 cm, shelf depth 25 cm.**

Complete units with panels, steel shelves, frame and fittings.  
 Heights include adjustable feet (2 cm).

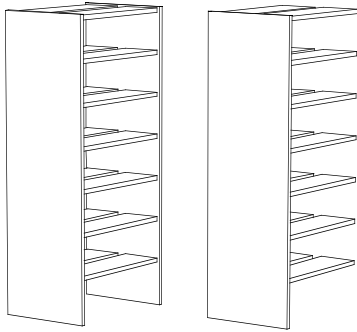

**Height 212 cm, 6 shelves + top shelf on each side.**

Starter bay 75 cm  
 Add-on bay 75 cm

BB78100127226245  
 BB78101127226245

Starter bay 90 cm  
 Add-on bay 90 cm

BB78100129226245  
 BB78101129226245

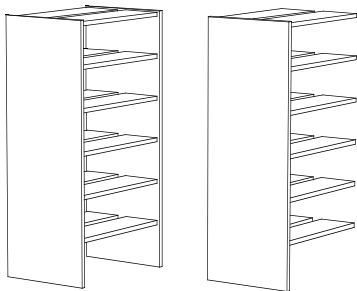

**Height 182 cm, 5 shelves + top shelf on each side.**

Starter bay 75 cm  
 Add-on bay 75 cm

BB78100827225245  
 BB78101827225245

Starter bay 90 cm  
 Add-on bay 90 cm

BB78100829225245  
 BB78101829225245

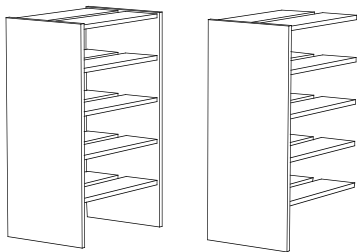

**Height 152 cm, 4 shelves + top shelf on each side.**

Starter bay 75 cm  
 Add-on bay 75 cm

BB78100527224245  
 BB78101527224245

Starter bay 90 cm  
 Add-on bay 90 cm

BB78100529224245  
 BB78101529224245

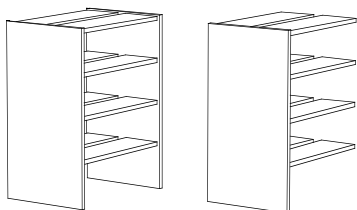

**Height 122 cm, 3 shelves + top shelf on each side.**

Starter bay 75 cm  
 Add-on bay 75 cm

BB78100227223245  
 BB78101227223245

Starter bay 90 cm  
 Add-on bay 90 cm

BB78100229223245  
 BB78101229223245

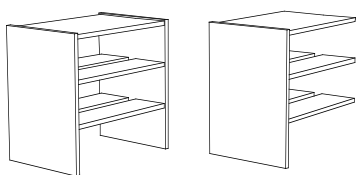

**Height 92 cm, 2 shelves + top shelf on each side.**

Starter bay 75 cm  
 Add-on bay 75 cm

BB78100727222245  
 BB78101727222245

Starter bay 90 cm  
 Add-on bay 90 cm

BB78100729222245  
 BB78101729222245

Softline double-sided bays.  
**Panel depth 69 cm, shelf depth 30 cm.**

Complete units with panels, steel shelves, frame and fittings.  
 Heights include adjustable feet (2 cm).

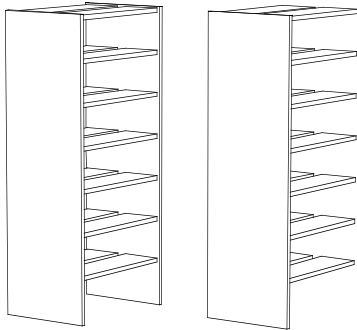

**Height 212 cm, 6 shelves + top shelf on each side.**

Starter bay 75 cm  
 Add-on bay 75 cm

BB78100137226245  
 BB78101137226245

Starter bay 90 cm  
 Add-on bay 90 cm

BB78100139226245  
 BB78101139226245

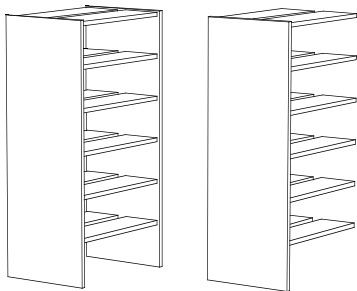

**Height 182 cm, 5 shelves + top shelf on each side.**

Starter bay 75 cm  
 Add-on bay 75 cm

BB78100837225245  
 BB78101837225245

Starter bay 90 cm  
 Add-on bay 90 cm

BB78100839225245  
 BB78101839225245

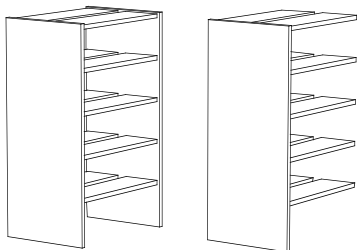

**Height 152 cm, 4 shelves + top shelf on each side.**

Starter bay 75 cm  
 Add-on bay 75 cm

BB78100537224245  
 BB78101537224245

Starter bay 90 cm  
 Add-on bay 90 cm

BB78100539224245  
 BB78101539224245

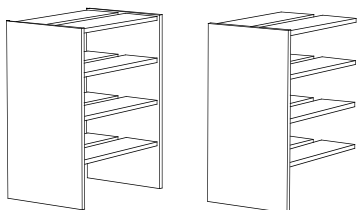

**Height 122 cm, 3 shelves + top shelf on each side.**

Starter bay 75 cm  
 Add-on bay 75 cm

BB78100237223245  
 BB78101237223245

Starter bay 90 cm  
 Add-on bay 90 cm

BB78100239223245  
 BB78101239223245

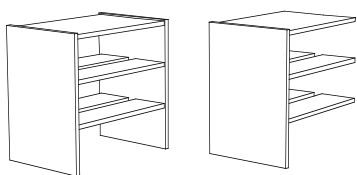

**Height 92 cm, 2 shelves + top shelf on each side.**

Starter bay 75 cm  
 Add-on bay 75 cm

BB78100737222245  
 BB78101737222245

Starter bay 90 cm  
 Add-on bay 90 cm

BB78100739222245  
 BB78101739222245



Softline double-sided bays.  
**Panel depth 89 cm, shelf depth 40 cm.**

Complete units with panels, steel shelves, frame and fittings.  
 Heights include adjustable feet (2 cm).

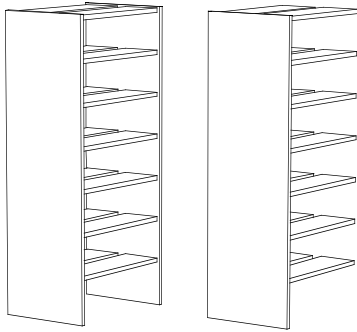

**Height 212 cm, 6 shelves + top shelf on each side.**

Starter bay 75 cm  
 Add-on bay 75 cm

BB78100147226245  
 BB78101147226245

Starter bay 90 cm  
 Add-on bay 90 cm

BB78100149226245  
 BB78101149226245

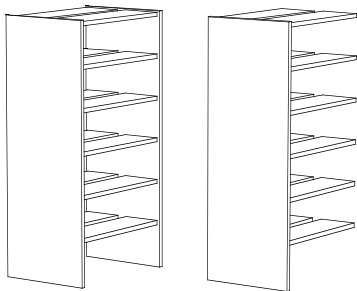

**Height 182 cm, 5 shelves + top shelf on each side.**

Starter bay 75 cm  
 Add-on bay 75 cm

BB78100847225245  
 BB78101847225245

Starter bay 90 cm  
 Add-on bay 90 cm

BB78100849225245  
 BB78101849225245

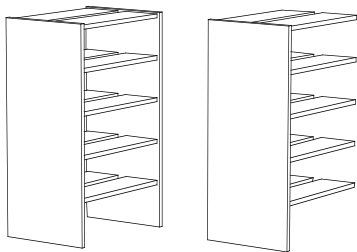

**Height 152 cm, 4 shelves + top shelf on each side.**

Starter bay 75 cm  
 Add-on bay 75 cm

BB78100547224245  
 BB78101547224245

Starter bay 90 cm  
 Add-on bay 90 cm

BB78100549224245  
 BB78101549224245

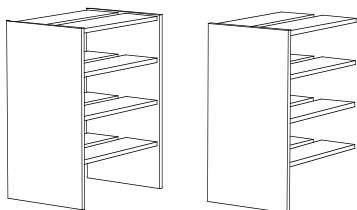

**Height 122 cm, 3 shelves + top shelf on each side.**

Starter bay 75 cm  
 Add-on bay 75 cm

BB78100247223245  
 BB78101247223245

Starter bay 90 cm  
 Add-on bay 90 cm

BB78100249223245  
 BB78101249223245

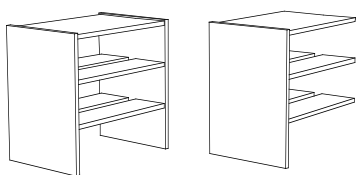

**Height 92 cm, 2 shelves + top shelf on each side.**

Starter bay 75 cm  
 Add-on bay 75 cm

BB78100747222245  
 BB78101747222245

Starter bay 90 cm  
 Add-on bay 90 cm

BB78100749222245  
 BB78101749222245

**Softline end panel bays.**

Complete units with panels, shelves, wood back panels and fittings.  
Heights include adjustable feet (2 cm). Place the end panel unit  
against a 59 or 69 cm deep double-sided panel.

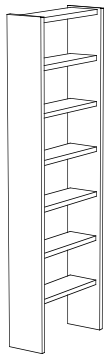

Softline.

**Height 212 cm, 6 wood shelves + wood top.**

Softline bay in total width 53 cm (for panels 59 cm deep)

Softline bay in total width 63 cm (for panels 69 cm deep)

BB78110128

BB78110129

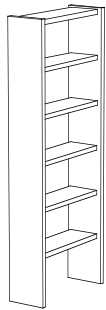
**Height 182 cm, 5 wood shelves + wood top.**

Softline bay in total width 53 cm (for panels 59 cm deep)

Softline bay in total width 63 cm (for panels 69 cm deep)

BB78110828

BB78110829

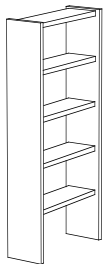
**Height 152 cm, 4 wood shelves + wood top.**

Softline bay in total width 53 cm (for panels 59 cm deep)

Softline bay in total width 63 cm (for panels 69 cm deep)

BB78110528

BB78110529

**Accessories for the end panel shelving units.**

Clear acrylic sloping shelf incl. mounting hardware.

For unit width 53 cm

For unit width 63 cm

B7840358

B7840359

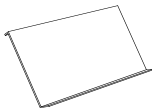

Wood shelf incl. mounting hardware. Thickness 22 mm.

Top wood shelf for unit width 53 cm

Wood shelf for unit width 53 cm

Bottom wood shelf for unit width 53 cm

B7840278

B7840298

B7840318

Top wood shelf for unit width 63 cm

Wood shelf for unit width 63 cm

Bottom wood shelf for unit width 63 cm

B7840279

B7840299

B7840319

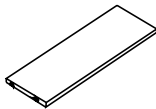

**Softline Singles.**

**Panel depth 36 cm or 69 cm, metal sloping shelf depth 36 cm and metal storage shelf depth 30 cm. Back panel and kickplate in melamine , kickplate height 12 cm for panel height 182 cm and 21 cm for panel height 212 cm .**

Complete units with panels, shelves, back panel, kickplate and fittings. Heights include adjustable feet (2 cm). Behind the lift-up display shelves are compartments providing space for piles of back issues.

**Softline.**

**Height 212 cm, 5 sloping metal shelves and 5 metal storage shelves + top shelf.**

Softline single-sided starter bay 34 cm  
Softline single-sided add-on bay 32 cm

BB78120131  
BB78121131

**Height 182 cm, 4 sloping metal shelves and 4 metal storage shelves + top shelf.**

Softline single-sided starter bay 34 cm  
Softline single-sided add-on bay 32 cm

BB78120831  
BB78121831

**Height 212 cm, 5 sloping metal shelves and 5 metal storage shelves + top shelf on each side.**

Softline double-sided starter bay 34 cm  
Softline double-sided add-on bay 32 cm

BB78120132  
BB78121132

**Height 182 cm, 4 sloping metal shelves and 4 metal storage shelves + top shelf on each side.**

Softline double-sided starter bay 34 cm  
Softline double-sided add-on bay 32 cm

BB78120832  
BB78121832

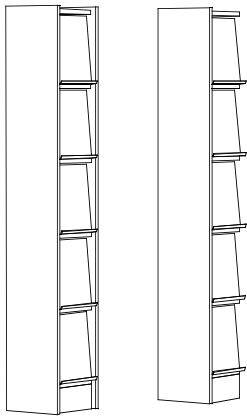

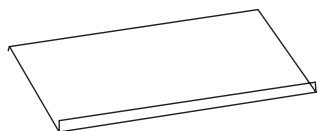

## Sloping steel shelves.

Sloping steel shelf w. 75 d. 32 cm

Sloping steel shelf w. 90 d. 32 cm

B7830207

B7830209

The shelf can be placed in 45° or 60° angle

## Reverse-tilted shelves.

Bracket for reverse-tilted shelf 7,5° for panel d. 46 cm, left

B783017348

Bracket for reverse-tilted shelf 7,5° for panel d. 46 cm, right

B783017349

**NB:** Use steel shelf d. 30 cm:

Steel shelf with steel front edge w. 75 d. 30 cm

B40100137

Steel shelf with steel front edge w. 90 d. 30 cm

B40100139

Bracket for reverse-tilted shelf 7,5° for panel d. 36 cm and 46 cm, left

B783017238

Bracket for reverse-tilted shelf 7,5° for panel d. 36 cm and 46 cm, right

B783017239

**NB:** Use steel shelf d. 25 cm:

Steel shelf with steel front edge w. 75 d. 25 cm

B40100127

Steel shelf with steel front edge w. 90 d. 25 cm

B40100129

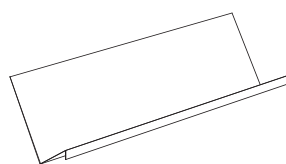

## Angled bottom shelf.

Angled bottom shelf w. 75 x h. 24 x d. 13 cm

B7825907

Angled bottom shelf w. 90 x h. 24 x d. 13 cm

B7825909

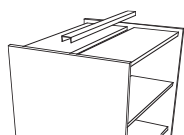

## U-fill in pieces.

U-fill in piece for module w. 75 cm

B7860157

U-fill in piece for module w. 90 cm

B7860159

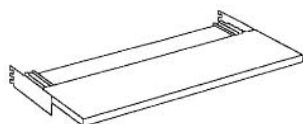

## Steel pull-out shelf.

Dim. h. 7.5 x d. 30 x w. 90 cm

B7851603

Dim. h. 7.5 x d. 22.5 x w. 90 cm

B7851601

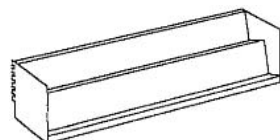

## Pocket book shelf.

Dim. h. 20 x d. 22.5 x w. 90 cm

B785150

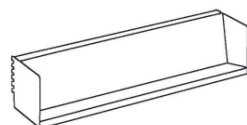

## Shelf for audio cassettes.

Dim. h. 20 x d. 22.5 x w. 90 cm.

B785140

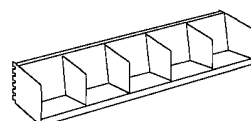

## Shelf for CD/video.

With 4 dividers. Dim. h. 15 x d. 22.5 x w. 90 cm.

B785130

For panel d. 25/30/40 cm.

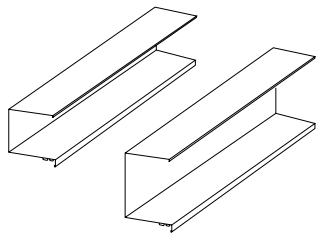
**Media steel shelves.**

CD shelf incl. fittings, width 75 cm  
 CD shelf incl. fittings, width 90 cm

B7851737  
 B7851739

Video shelf incl. fittings, width 75 cm  
 Video shelf incl. fittings, width 90 cm

B7851707  
 B7851709

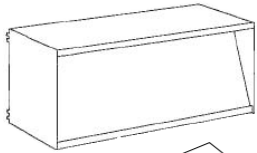
**Magazine storage shelf.**

For module d. 40 cm. Dim. h. 40 x d. 40 x w. 90 cm.

B785100

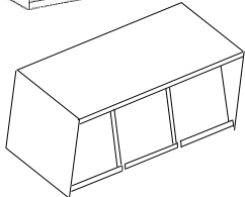
**Magazine storage shelf with three tip-up doors.**

For module d. 40 cm. Dim. h. 40 x d. 40 x w. 90 cm.

B785120

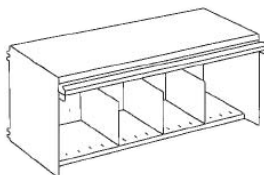
**Magazine storage shelf with three dividers.**

For module d. 40 cm. Dim. h. 40 x d. 40 x w. 90 cm.

B785110

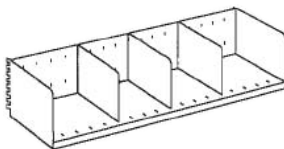
**Shelf with three dividers.**

For module d. 30 cm. Dim. h. 20 x d. 30 x w. 90 cm.  
 For module d. 25 cm. Dim. h. 20 x d. 22.5 x w. 90 cm.  
 Plate divider d. 30 cm  
 Plate divider d. 22 5 cm

B7850413  
 B7850412  
 B4010403  
 B4010401

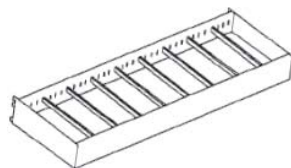
**Browsers.**

Single, dim. h. 10 x d. 30 x w. 90 cm for module d. 30 cm,  
 without dividers.

B7850001300

Single, dim. h. 20 x d. 40 x w. 90 cm for module d. 30 cm,  
 without dividers.

B7850003300

**NB:** shelf protrudes 7.5 cm.

Single, dim. h. 20 x d. 40 x w. 90 cm for module d. 40 cm,  
 without dividers.

B7850003400

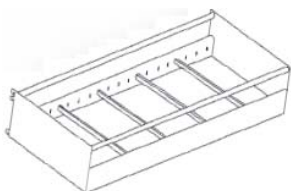

Double, dim. h. 20 x d. 40 x w. 90 cm for module d. 30 cm,  
 without dividers.

B7850004300

**NB:** shelf protrudes 7.5 cm.

Double, dim. h. 20 x d. 40 x w. 90 cm for module d. 40 cm,  
 without dividers.

B7850004400

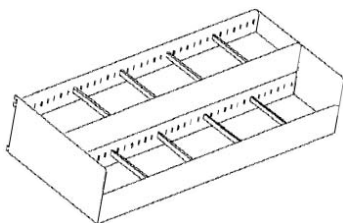

Divider for single browser h. 10 x d. 30 x w. 90 cm

B4011603

Divider for single browser h. 20 x d. 40 x w. 90 cm

B4011601

Divider for double browser h. 20 x d. 40 x w. 90 cm

B4011604

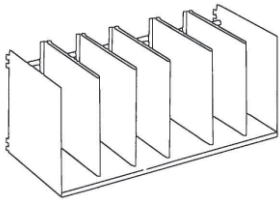

## Shelf with 5 sliding dividers.

Dim. h. 40 x d. 40 x w. 90 cm.

B785080

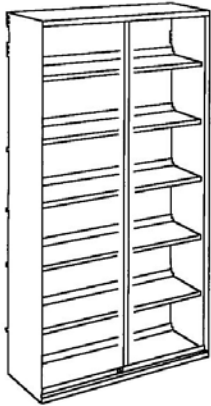

## Cabinet with glass sliding doors.

For module h. 212 cm. With 5 shelves + top and bottom shelf.

Dim. h. 182,5 x d. 30 x w. 90 cm.

B7850208

For module h. 182 cm. With 4 shelves + top and bottom shelf.

Dim. h. 152,5 x d. 30 x w. 90 cm.

B7850205

For module h. 152 cm. With 3 shelves + top and bottom shelf.

Dim. h. 122,5 x d. 30 x w. 90 cm.

B7850202

For module h. 122 cm. With 2 shelves + top and bottom shelf.

Dim. h. 92,5 x d. 30 x w. 90 cm.

B7850209

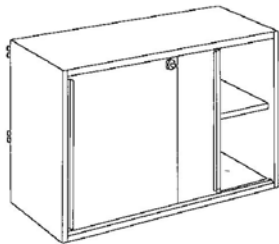

## Steel cabinet with sliding doors for panel d.40 cm.

Low model. Dim. h. 62.5 x d. 40 x w. 90 cm.

B7850306

Tall model. Dim. h. 80 x d. 40 x w. 90 cm.

B7850307



## Steel cabinet with tip-up door and lock.

Steel cabinet. Dim. h. 40 x d. 40 x w. 90 cm.

B7850900

Steel cabinet incl. 1 pull-out frame for suspension files

B7850902



## Wheelstand.

Wheelstand for double-sided bay w. 75 cm, excl. wheels

B7860007

Wheelstand for double-sided bay w. 90 cm, excl. wheels

B7860009

Wheel without brake

B7860100

Wheel with brake

B7860101

**Flat steel shelves.**

The steel shelves with back stops are included when ordering complete bays. However it may be necessary to order separate components as spare parts or when existing shelving units are rearranged.

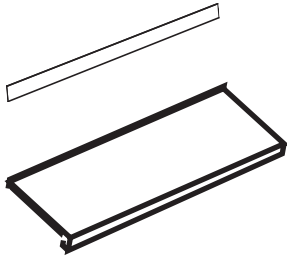

Flat steel shelf w. 75 d. 25 cm with backstop and book support rail	B40101327
Flat steel shelf w. 90 d. 25 cm with backstop and book support rail	B40101329
Flat steel shelf w. 75 d. 30 cm with backstop and book support rail	B40101337
Flat steel shelf w. 90 d. 30 cm with backstop and book support rail	B40101339
Flat steel shelf w. 75 d. 40 cm with backstop and book support rail	B40101347
Flat steel shelf w. 90 d. 40 cm with backstop and book support rail	B40101349

Top steel shelf w. 75 d. 25 cm without backstop, with book support rail	B40101127
Top steel shelf w. 90 d. 25 cm without backstop, with book support rail	B40101129
Top steel shelf w. 75 d. 30 cm without backstop, with book support rail	B40101137
Top steel shelf w. 90 d. 30 cm without backstop, with book support rail	B40101139
Top steel shelf w. 75 d. 40 cm without backstop, with book support rail	B40101147
Top steel shelf w. 90 d. 40 cm without backstop, with book support rail	B40101149

Bracket for flat steel shelf and top steel shelf d. 25 cm, left	B78300128
Bracket for flat steel shelf and top steel shelf d. 25 cm, right	B78300129
Bracket for flat steel shelf and top steel shelf d. 30 cm, left	B78300138
Bracket for flat steel shelf and top steel shelf d. 30 cm, right	B78300139
Bracket for flat steel shelf and top steel shelf d. 40 cm, left	B78300148
Bracket for flat steel shelf and top steel shelf d. 40 cm, right	B78300149

Extra fittings for top, bottom and middle shelf	B784738
---	---------

**Flat steel shelves with backedge.**

This is an optional steel shelf for those who prefer backedge book supports instead of hanging book supports.

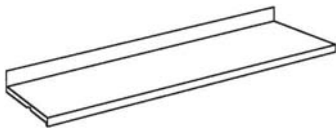

Flat steel shelf with backedge w. 75 d. 25 cm	B40100127
Flat steel shelf with backedge w. 90 d. 25 cm	B40100129
Flat steel shelf with backedge w. 75 d. 30 cm	B40100137
Flat steel shelf with backedge w. 90 d. 30 cm	B40100139
Flat steel shelf with backedge w. 75 d. 40 cm	B40100147
Flat steel shelf with backedge w. 90 d. 40 cm	B40100149

Top steel shelf without backedge w. 75 d. 25 cm	B40100327
Top steel shelf without backedge w. 90 d. 25 cm	B40100329
Top steel shelf without backedge w. 75 d. 30 cm	B40100337
Top steel shelf without backedge w. 90 d. 30 cm	B40100339
Top steel shelf without backedge w. 75 d. 40 cm	B40100347
Top steel shelf without backedge w. 90 d. 40 cm	B40100349

---

Bracket for flat steel shelf and top steel shelf d. 25 cm, left	B78300128
Bracket for flat steel shelf and top steel shelf d. 25 cm, right	B78300129
Bracket for flat steel shelf and top steel shelf d. 30 cm, left	B78300138
Bracket for flat steel shelf and top steel shelf d. 30 cm, right	B78300139
Bracket for flat steel shelf and top steel shelf d. 40 cm, left	B78300148
Bracket for flat steel shelf and top steel shelf d. 40 cm, right	B78300149

Extra fittings for top, bottom and middle shelf	B784738
---	---------

### Top shelf with sign profile.

This is an optional top steel shelf that is not included when ordering complete shelving bays.

Top shelf with sign profile w. 75 d. 25 cm	B40100527
Top shelf with sign profile w. 90 d. 25 cm	B40100529
Top shelf with sign profile w. 75 d. 30 cm	B40100537
Top shelf with sign profile w. 90 d. 30 cm	B40100539
Top shelf with sign profile w. 75 d. 40 cm	B40100547
Top shelf with sign profile w. 90 d. 40 cm	B40100549

Bracket for top shelf with sign profile d. 25 cm, left	B78301528
Bracket for top shelf with sign profile d. 25 cm, right	B78301529
Bracket for top shelf with sign profile d. 30 cm, left	B78301538
Bracket for top shelf with sign profile d. 30 cm, right	B78301539
Bracket for top shelf with sign profile d. 40 cm, left	B78301548
Bracket for top shelf with sign profile d. 40 cm, right	B78301549

---



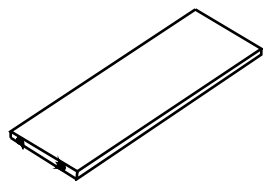

### Wood shelves.

Flat wood shelf w. 75 d. 25 cm	B78210227
Flat wood shelf w. 75 d. 30 cm	B78210237
Flat wood shelf w. 75 d. 40 cm	B78210247
Flat bottom wood shelf w. 75 d. 25 cm	B78210427
Flat bottom wood shelf w. 75 d. 30 cm	B78210437
Flat bottom wood shelf w. 75 d. 40 cm	B78210447
Flat top wood shelf w. 75 d. 25 cm full depth	B782100279
Flat top wood shelf w. 75 d. 30 cm full depth	B782100379
Flat top wood shelf w. 75 d. 40 cm full depth	B782100479
Flat top wood shelf w. 75 d. 25 cm	B782100278
Flat top wood shelf w. 75 d. 30 cm	B782100378
Flat top wood shelf w. 75 d. 40 cm	B782100478
Flat top wood shelf w. 75 d. 25/25 cm full depth	B78210627
Flat top wood shelf w. 75 d. 30/30 cm full depth	B78210637
Flat top wood shelf w. 75 d. 40/40 cm full depth	B78210647
Flat wood shelf w. 90 d. 25 cm	B78210229
Flat wood shelf w. 90 d. 30 cm	B78210239
Flat wood shelf w. 90 d. 40 cm	B78210249
Flat bottom wood shelf w. 90 d. 25 cm	B78210429
Flat bottom wood shelf w. 90 d. 30 cm	B78210439
Flat bottom wood shelf w. 90 d. 40 cm	B78210449
Flat top wood shelf w. 90 d. 25 cm full depth	B782100299
Flat top wood shelf w. 90 d. 30 cm full depth	B782100399
Flat top wood shelf w. 90 d. 40 cm full depth	B782100499
Flat top wood shelf w. 90 d. 25 cm	B782100298
Flat top wood shelf w. 90 d. 30 cm	B782100398
Flat top wood shelf w. 90 d. 40 cm	B782100498
Flat top wood shelf w. 90 d. 25/25 cm full depth	B78210629
Flat top wood shelf w. 90 d. 30/30 cm full depth	B78210639
Flat top wood shelf w. 90 d. 40/40 cm full depth	B78210649
60° sloping wood shelf w. 90 cm for all depths	B7821089

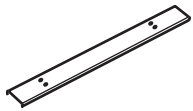

**Book support rail for wood shelves  
and top wood shelves.**

Book support rail for wood shelf w. 75 cm  
Book support rail for wood shelf w. 90 cm

B4022007  
B4022009

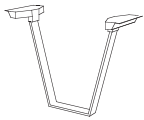

Hanging book support, normal size 20 cm  
Hanging book support, folio size 25 cm

B4011242  
B4011245

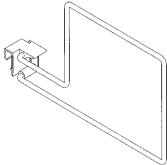

Backedge book support shelf d. 22,5 cm.  
Backedge book support shelf d. 30 cm.  
Backedge book support shelf d. 30 cm, high model.  
Backedge book support shelf d. 22,5 cm, mirror-inverted  
Backedge book support shelf d. 30 cm, mirror-inverted

B4011221  
B4011222  
B4011223  
B4011224  
B4011225

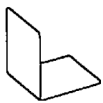

Angle book support 15 x 15 x 15 cm

B401120

**Wood shelves with wood dividers.**

Complete starter shelf with 7 dividers.  
Dim. w. 90 x d. 30 x h. 30 cm.  
Complete add-on shelf with 7 dividers.  
Dim. w. 90 x d. 30 x h. 30 cm.

B7840161  
B7840162

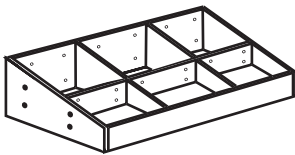

**Picture book box with 6 compartments.**

Picture book box in wood with 4 adjustable dividers  
to form 6 compartments for picture books.  
Dim. w. 90 x d. 50 x h. 25/10 cm.

B784000

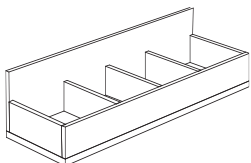

**Picture book box with 4 compartments.**

Dim. w. 90 x d. 30 x h. 22/12 cm.  
The underside of the bottom shelf is predrilled to take  
an add-on shelf with 7 dividers from page 16.

B784002

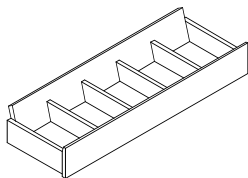

**CD/DVD display box.**

Box used to display CD or DVD cases.  
Pull-out fittings with 100% expansion.  
Size w. 90 x d. 30 x h. 17/13 cm.

B784004

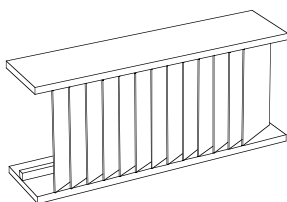

**Wood shelves with acrylic dividers.**

Complete starter shelf with 13 acrylic dividers for d.25/30/40 cm.  
Dim. w. 90 x d. 25 x h. 30 cm.  
Complete add-on shelf with 13 acrylic dividers for d.25/30/40 cm.  
Dim. w. 90 x d. 25 x h. 30 cm.

B7840201  
B7840202

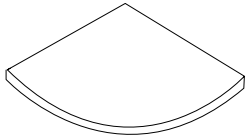
**Wood corner shelves.**

Wood corner shelf 45° for panel d. 59 cm  
 Wood corner shelf 90° for panel d. 59 cm  
 Wood corner shelf 45° for panel d. 69 cm  
 Wood corner shelf 90° for panel d. 69cm

B7840061  
 B7840062  
 B7840063  
 B7840064

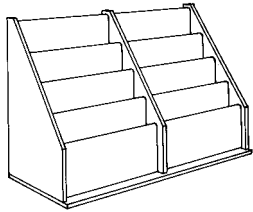
**Newspaper cassette.**

This display unit can be mounted in the d. 30 cm, w. 90 cm shelving units. The bottom shelf and side panels are made of wood and the dividers are made of acrylic. The unit is used as a component in a shelving bay only, not as a free-standing unit. 8 compartments for newspapers. Dim. w. 90 x d. 30 x h. 61 cm.

B784008

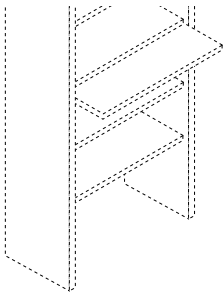
**Wood pull-out shelf.**

For module w. 90 d. 30 cm.

B7840109

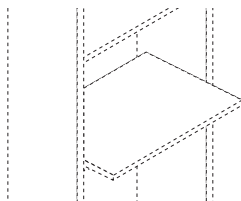
**Writing surface.**

Dim. w. 90 x d. 60 cm  
 Dim. w. 90 x d. 50 cm  
 Dim. w. 90 x d. 40 cm  
 Bracket Right  
 Bracket Left

B7840126  
 B7840125  
 B7840124  
 B7840149  
 B7840148

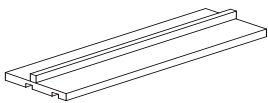
**Shelf for Daisy cases.**

Wood shelf for talking book cases Daisy. The shelf can also be used for other types of cases. A movable wood strip makes it possible to adjust the depth in accordance with the size of the case.

Shelf for Daisy cases w. 90 d. 25 cm  
 Shelf for Daisy cases w. 90 d. 30 cm.

B7840252  
 B7840253



### Doors for 12 cm high kickplate.

The doors can be mounted in the 90 cm wide single- or double-sided shelving units. The wood frame for the doors with toughened glass panel is 1,5 x 4 cm.

When using glass panel doors or wood doors you must order top and bottom shelves in wood.

Glass panel doors with frame h. 212 w. 90 cm

B780008194

Glass panel doors with frame h. 182 w. 90 cm

B780008894

Glass panel doors with frame h. 152 w. 90 cm

B780008594

Glass panel doors with frame h. 122 w. 90 cm

B780008294

Glass panel doors with frame h. 92 w. 90 cm

B780008794

Wood doors without frame h. 212 w. 90 cm

B780008196

Wood doors without frame h. 182 w. 90 cm

B780008896

Wood doors without frame h. 152 w. 90 cm

B780008596

Wood doors without frame h. 122 w. 90 cm

B780008296

Wood doors without frame h. 92 w. 90 cm

B780008796

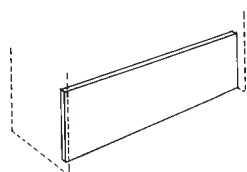

### Kickplates.

The kickplates are designed to cover the opening between the bottom shelf and the lower edges of the upright panels. The kickplates are 12 cm high.

Kickplate in wood w. 90 cm

B7820009

Kickplate in wood w. 75 cm

B7820007



### Softline/ Slatwall end panels.

The slatwall end panels can be mounted at the end of double-sided rows which are 212, 182, 152 or 122 cm high. A slatwall end panel thus replaces an ordinary flat end panel.

Softline Slatwall end panel h. 212 d. 25/25 cm

B78000412

Softline Slatwall end panel h. 212 d. 30/30 cm

B78000413

Softline Slatwall end panel h. 182 d. 25/25 cm

B78000482

Softline Slatwall end panel h. 182 d. 30/30 cm

B78000483

Softline Slatwall end panel h. 152 d. 25/25 cm

B78000452

Softline Slatwall end panel h. 152 d. 30/30 cm

B78000453

Softline Slatwall end panel h. 122 d. 25/25 cm

B78000422

Softline Slatwall end panel h. 122 d. 30/30 cm

B78000423

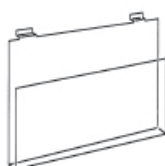

### Accessories for Slatwall end panel.

Various displays made from clear acrylic.

Brochure holder, wide, h. 25 x w. 50 x d. 5 cm

B4100201111

Media shelf for display panel h. 10 x w. 60 x d. 4 cm

B4100201010



Bookholder, h. 16 x w. 22 x d. 9.5 cm

B4100201616

Bookholder, h. 16 x w. 7.5 x d. 9 cm

B4100201515

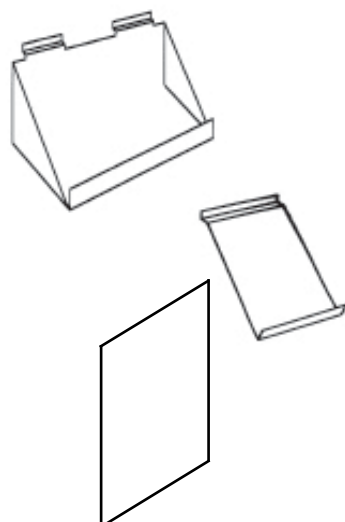

Sloping shelf, h. 20 x w. 50 x d. 30 cm

B4100201212

Sloping shelf, h. 25 x w. 12.5 x d. 22 cm

B4100201313

Sloping shelf, h. 30 x w. 15 x d. 23 cm

B4100201414

Poster holder, A5 size

B4100202222

Poster holder, A4 size

B4100202323

**Signs**

The metal signs are screwed into an end panel at the height you choose.

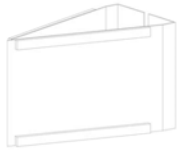

Range Finder for label in size h.98 v w. 140 mm

B4011007

Flat sign A4 vertical including acrylic cover

B40110337

Flat sign A3 vertical including acrylic cover

B40110378

Flat sign A3 horizontal including acrylic cover

B40110379

**Steel frame.**

The steel frame is included when ordering complete bays. However it may be necessary to order separate components as Spare parts or when existing shelving units are rearranged.  
Frame for width 75 cm (incl. fittings)  
Frame for width 90 cm (incl. fittings)

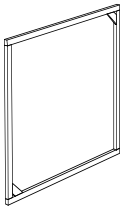

B7822137

B7822139

**Wood back panels.**

The wood back panels are designed for use in lieu of the tubular steel frame in any single-sided or double-sided shelving bays.

**Back panels for use with steel top shelf or wood top.**

Wood back panel h. 212 w. 75 cm  
Wood back panel h. 182 w. 75 cm  
Wood back panel h. 152 w. 75 cm  
Wood back panel h. 122 w. 75 cm  
Wood back panel h. 92 w. 75 cm

B782200174X

B782200874X

B782200574X

B782200274X

B782200774X

Wood back panel h. 212 w. 90 cm  
Wood back panel h. 182 w. 90 cm  
Wood back panel h. 152 w. 90 cm  
Wood back panel h. 122 w. 90 cm  
Wood back panel h. 92 w. 90 cm

B782200194X

B782200894X

B782200594X

B782200294X

B782200794X

Instead of X fill in

2 = Veneer

4 = Painted

**Back panels for use with wooden top shelf in full depth.**

Wood back panel h. 212 w. 75 cm  
 Wood back panel h. 182 w. 75 cm  
 Wood back panel h. 152 w. 75 cm  
 Wood back panel h. 122 w. 75 cm  
 Wood back panel h. 92 w. 75 cm

B782200176X  
 B782200876X  
 B782200576X  
 B782200276X  
 B782200776X

Wood back panel h. 212 w. 90 cm  
 Wood back panel h. 182 w. 90 cm  
 Wood back panel h. 152 w. 90 cm  
 Wood back panel h. 122 w. 90 cm  
 Wood back panel h. 92 w. 90 cm

B782200196X  
 B782200896X  
 B782200596X  
 B782200296X  
 B782200796X

Instead of X fill in

2 = Veneer  
 4 = Painted

**Melamine back panels.**

The melamine back panels are designed for use in lieu of the tabular steel frame in any single-sided or double-sided shelving bays.

**Back panels for use with steel top shelf or wood top.**

Melamine back panel h. 212 w. 75 cm  
 Melamine back panel h. 182 w. 75 cm  
 Melamine back panel h. 152 w. 75 cm  
 Melamine back panel h. 122 w. 75 cm  
 Melamine back panel h. 92 w. 75 cm

B7822001746  
 B7822008746  
 B7822005746  
 B7822002746  
 B7822007746

Melamine back panel h. 212 w. 90 cm  
 Melamine back panel h. 182 w. 90 cm  
 Melamine back panel h. 152 w. 90 cm  
 Melamine back panel h. 122 w. 90 cm  
 Melamine back panel h. 92 w. 90 cm

B7822001946  
 B7822008946  
 B7822005946  
 87822002946  
 B7822007946

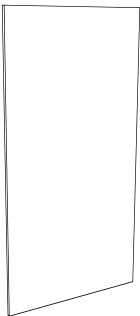
**Back panels for use with wooden top shelf in full depth.**

Melamine back panel h. 212 w. 75 cm  
 Melamine back panel h. 182 w. 75 cm  
 Melamine back panel h. 152 w. 75 cm  
 Melamine back panel h. 122 w. 75 cm  
 Melamine back panel h. 92 w. 75 cm

B7822001766  
 B7822008766  
 B7822005766  
 B7822002766  
 B7822007766

Melamine back panel h. 212 w. 90 cm  
 Melamine back panel h. 182 w. 90 cm  
 Melamine back panel h. 152 w. 90 cm  
 Melamine back panel h. 122 w. 90 cm  
 Melamine back panel h. 92 w. 90 cm

B7822001966  
 B7822008966  
 B7822005966  
 B7822002966  
 B7822007966

## SOFTLINE SHELVING SYSTEM

## REMARKS

## ART.NO

H. 212 x d. 31 cm left panel single	Softline	B780000 1216
H. 212 x d. 31 cm right panel single	Softline	B780000 1217
H. 212 x d. 31 cm intermediate panel single	Softline	B780000 1218
H. 212 x d. 59 cm outside panel double	Softline	B780000 1228
H. 212 x d. 59 cm intermediate panel double	Softline	B780000 1229
H. 212 x d. 36 cm left panel single	Softline	B780000 1316
H. 212 x d. 36 cm right panel single	Softline	B780000 1317
H. 212 x d. 36 cm intermediate panel single	Softline	B780000 1318
H. 212 x d. 69 cm outside panel double	Softline	B780000 1328
H. 212 x d. 69 cm intermediate panel single	Softline	B780000 1329
H. 212 x d. 46 cm left panel single	Softline	B780000 1416
H. 212 x d. 46 cm right panel single	Softline	B780000 1417
H. 212 x d. 46 cm intermediate panel single	Softline	B780000 1418
H. 212 x d. 89 cm outside panel double	Softline	B780000 1428
H. 212 x d. 89 cm intermediate panel double	Softline	B780000 1429
H. 182 x d. 31 cm left panel single	Softline	B780000 8216
H. 182 x d. 31 cm right panel single	Softline	B780000 8217
H. 182 x d. 31 cm intermediate panel single	Softline	B780000 8218
H. 182 x d. 59 cm outside panel double	Softline	B780000 8228
H. 182 x d. 59 cm intermediate panel double	Softline	B780000 8229
H. 182 x d. 36 cm left panel single	Softline	B780000 8316
H. 182 x d. 36 cm right panel single	Softline	B780000 8317
H. 182 x d. 36 cm intermediate panel single	Softline	B780000 8318
H. 182 x d. 69 cm outside panel double	Softline	B780000 8328
H. 182 x d. 69 cm intermediate panel single	Softline	B780000 8329
H. 182 x d. 46 cm left panel single	Softline	B780000 8416
H. 182 x d. 46 cm right panel single	Softline	B780000 8417
H. 182 x d. 46 cm intermediate panel single	Softline	B780000 8418
H. 182 x d. 89 cm outside panel double	Softline	B780000 8428
H. 182 x d. 89 cm intermediate panel double	Softline	B780000 8429
H. 152 x d. 31 cm left panel single	Softline	B780000 5216
H. 152 x d. 31 cm right panel single	Softline	B780000 5217
H. 152 x d. 31 cm intermediate panel single	Softline	B780000 5218
H. 152 x d. 59 cm outside panel double	Softline	B780000 5228
H. 152 x d. 59 cm intermediate panel double	Softline	B780000 5229
H. 152 x d. 36 cm left panel single	Softline	B780000 5316
H. 152 x d. 36 cm right panel single	Softline	B780000 5317
H. 152 x d. 36 cm intermediate panel single	Softline	B780000 5318
H. 152 x d. 69 cm outside panel double	Softline	B780000 5328
H. 152 x d. 69 cm intermediate panel single	Softline	B780000 5329
H. 152 x d. 46 cm left panel single	Softline	B780000 5416
H. 152 x d. 46 cm right panel single	Softline	B780000 5417
H. 152 x d. 46 cm intermediate panel single	Softline	B780000 5418
H. 152 x d. 89 cm outside panel double	Softline	B780000 5428
H. 152 x d. 89 cm intermediate panel double	Softline	B780000 5429



## SOFTLINE SHELVING SYSTEM

## REMARKS

## ART.NO

H. 122 x d. 31 cm left panel single	Softline	B780000 2216
H. 122 x d. 31 cm right panel single	Softline	B780000 2217
H. 122 x d. 31 cm intermediate panel single	Softline	B780000 2217
H. 122 x d. 59 cm outside panel double	Softline	B780000 2228
H. 122 x d. 59 cm intermediate panel double	Softline	B780000 2229
H. 122 x d. 36 cm left panel single	Softline	B780000 2316
H. 122 x d. 36 cm right panel single	Softline	B780000 2317
H. 122 x d. 36 cm intermediate panel single	Softline	B780000 2318
H. 122 x d. 69 cm outside panel double	Softline	B780000 2328
H. 122 x d. 69 cm intermediate panel double	Softline	B780000 2329
H. 122 x d. 46 cm left panel single	Softline	B780000 2416
H. 122 x d. 46 cm right panel single	Softline	B780000 2417
H. 122 x d. 46 cm intermediate panel single	Softline	B780000 2418
H. 122 x d. 89 cm outside panel double	Softline	B780000 2428
H. 122 x d. 89 cm intermediate panel double	Softline	B780000 2429
H.92 x d. 31 cm left panel single	Softline	B780000 7216
H.92 x d. 31 cm right panel single	Softline	B780000 7217
H. 92 x d. 31 cm intermediate panel single	Softline	B780000 7218
H. 92 x d. 59 cm outside panel double	Softline	B780000 7228
H. 92 x d. 59 cm intermediate panel double	Softline	B780000 7229
H. 92 x d. 36 cm left panel single	Softline	B780000 7316
H. 92 x d. 36 cm right panel single	Softline	B780000 7317
H. 92 x d. 36 cm intermediate panel single	Softline	B780000 7318
H.92 x d. 69 cm outside panel double	Softline	B780000 7328
H. 92 x d. 69 cm intermediate panel double	Softline	B780000 7329
H. 92 x d. 46 cm left panel single	Softline	B780000 7416
H. 92 x d. 46 cm right panel single	Softline	B780000 7417
H.92 x d. 46 cm intermediate panel single	Softline	B780000 7418
H. 92 x d. 89 cm outside panel double	Softline	B780000 7428
H. 92 x d. 89 cm intermediate panel double	Softline	B780000 7429