



PLANNER™ Activity Tables

PLANNER™ Single- & Two-Student Desk

PLANNER™ Three-Student Desk

PLANNER™ Lab Station



PLANNER™ Huddle™ Student Desk

How to use the Huddle-6 Desk



Face-to-Face



Side-by-Side



Half-Circle



6-Student — Full 6 ft. dia. circle

Huddle-6 Student Desks in a 6 ft. circle for collaborative learning classroom.

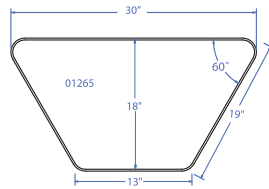

Huddle-6 (top down view)

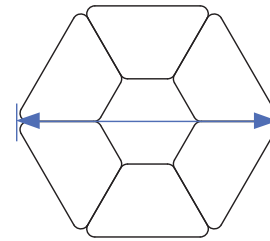

This configuration of Huddle-6 Desks is 6 ft. in diameter.



Huddle™ Student Desk

This compact, collaborative learning desk offers maximum strength and stability. Its size allows more students to fit in a classroom and its trapezoid desktop enables compact circles to be created for group work. Features handy backpack peg. Choose and from 10 standard laminate colors, 20 standard edge band and four leg colors. See size choices, below.

Shown with optional Steel Bookbox, Model 17015

- Patented backpack peg that keeps student items organized, can be positioned inside or outside of either leg.
- Adjustable desk height, from 22"-32" in 1" increments.
- Durable desktop available in 1 1/4" or 3/4" thickness, all with a high-pressure laminate surface.
- Steel front panel that adds stability.
- "H" Frame construction adds strength.
- Rugged powder coat surface on legs resists wear.
- Welded-end leg sets don't shimmy or rock.

Model	Description	D"	W"	H"	F.C.	Cube	Wt.	UPS
01265	Huddle-6 Student Desk- 6' circle	18	30	22-32	70	1.1	35	*
01266	Huddle-8 Student Desk - 7' circle	18	30	22-32	70	1.1	36	*
01267	Huddle-8LS	24	30	22-32	70	14.0	42	*

Smith System recommends the Huddle-6 and Huddle-8 for grades K-5; Huddle-8LS for upper grades.

Huddle Book Box

17015	Book Box for Huddle-6 Desk #01265 - 6" w/back	15	21	3.5	70	0.5	6	*
17016	Book Box for Huddle-8 Desk #01266 - 10" w/back	15	21	3.5	70	0.5	6	*

How to use the Huddle-8 Desk



Single



Side-by-Side



Half-Circle



8-Student — Full 7 ft. dia. circle

Huddle-8 Student Desks in a 7 ft. circle for collaborative learning classroom.

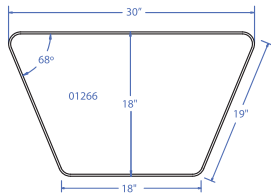

Huddle-8 (top down view)

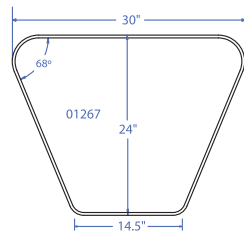

Huddle-8LS (top down view)

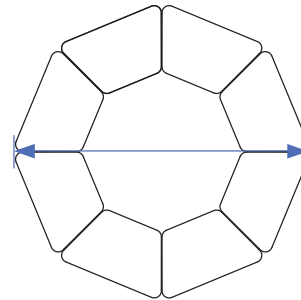

This configuration of Huddle-8 Desks is 7 ft. in diameter.

Planner Huddle Desks Have Top and Edge Choices

1 1/4" TOP

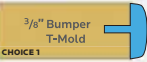

CHOICE 1

CHOICE 1 - 1 1/4" top with Bumper T-Mold
no letter to follow Model No.

CHOICE 2 - not available

H

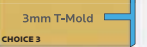

CHOICE 3

CHOICE 3 - 1 1/4" top with 3mm T-Mold
H to follow Model No.

CHOICE 4 - not available

G



CHOICE 5

CHOICE 5 - 3/4" top with 3mm T-Mold
G to follow Model No.

V



CHOICE 6

CHOICE 6 - 3/4" top with Bullet T-Mold
V to follow Model No.

Planner Student Desk Standard Laminate Color Choice

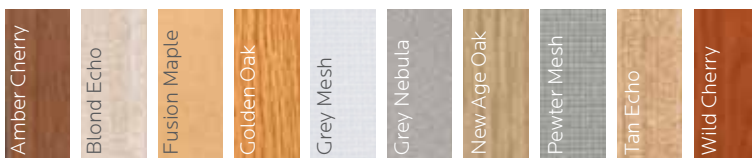

Planner Student Desk Leg Color Choice



Planner Student Desk Standard Edge Color Choice



PLANNER™ Single- & Two-Student Desk



Planner Single-Student Desk

This spacious desk offers maximum strength and stability and is best suited for traditional classrooms. Features handy backpack peg. Choose from 10 standard laminate colors, and 20 standard edge colors.

- Patented backpack peg that keeps student items organized can be positioned inside or outside of either leg.
- Adjustable desk height, from 22"-32" in 1" increments.
- Durable desktop available in 1 1/4" or 3/4" thickness, all with a high pressure laminate surface.
- Edge moldings resist wear, choices available (see chart).
- Steel front panel that adds stability.
- Rugged powder coat surface on legs resists wear.

Shown in Grey Mesh top with Persian Blue edge and Platinum frame.
Shown with optional Plato Stack Chair, Model 00950.

20" deep models

Model	Description	D"	W"	H"	F.C.	Cube	Wt.	UPS
01272	Planner Student Desk	20	27	22-32	70	1.0	36	*
01274	Planner Student Desk	20	36	22-32	70	1.4	42	*
01279	Planner Student Desk	20	32	22-32	70	1.8	40	

24" deep models

Model	Description	D"	W"	H"	F.C.	Cube	Wt.	UPS
01285	Planner Student Desk	24	27	22-32	70	1.3	42	*
01286	Planner Student Desk	24	36	22-32	70	1.8	50	*

Dimension Chart				
Model	A	B	C	D
01272	20"	15.25"	27"	21"
01274	20"	15.25"	36"	30"
01279	20"	15.25"	32"	26"
01285	24"	19.25"	27"	21"
01286	24"	19.25"	36"	30"
01273	20"	15.25"	27"	21"
01291	20"	15.25"	36"	30"

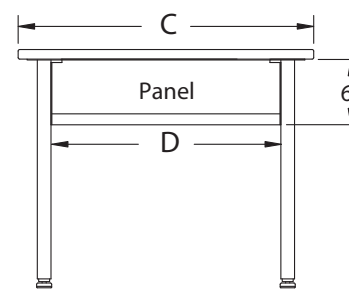
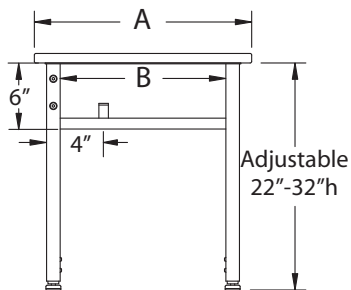

Hard Plastic Desk Top Color Choice



Planner Single-Student Desk with Hard Plastic Top

This desk offers maximum strength and stability and is best suited for traditional classrooms. Its spacious, durable hard plastic work surface provides ample working room for projects of all kinds. Features handy backpack peg. Choose from five hard plastic finishes, and four leg colors.

Model	Description	D"	W"	H"	F.C.	Cube	Wt.	UPS
01273	Planner Student Desk	20	27	22-32	70	1.0	36	*
01291	Planner Student Desk	20	36	22-32	70	1.4	42	*



Two-Student Planner Desk, Model 01280. Shown in Grey Nebula top with Navy edge and Navy frame. Shown with two optional Steel Bookboxes, Model 17190.

Planner Two-Student Desk

This desk offers maximum strength and stability while providing ample workspace for two students. Features handy backpack peg. Choose from 10 standard laminate colors, and 20 standard edge colors.

20" deep models

Model	Description	D"	W"	H"	F.C.	Cube	Wt.	UPS
01276	Planner Student Desk Two-student	20	48	22-32	70	1.8	50	*
01278	Planner Student Desk Two-student	20	54	22-32	70	2.0	54	
01280	Planner Student Desk Two-student	20	60	22-32	70	2.2	75	
01284	Planner Student Desk Two-student	20	72	22-32	70	2.5	89	



Dimension Chart				
Model	A	B	C	D
01276	20"	15.25"	48"	42"
01278	20"	15.25"	54"	48"
01280	20"	15.25"	60"	54"
01284	20"	15.25"	72"	66"
01287	24"	19.25"	48"	42"
01288	24"	19.25"	54"	48"
01289	24"	19.25"	60"	54"
01290	24"	19.25"	72"	66"

24" deep models

Model	Description	D"	W"	H"	F.C.	Cube	Wt.	UPS
01287	Planner Student Desk Two-student	24	48	22-32	70	2.2	61	
01288	Planner Student Desk Two-student	24	54	22-32	70	2.4	67	
01289	Planner Student Desk Two-student	24	60	22-32	70	2.7	71	
01290	Planner Student Desk Two-student	24	72	22-32	70	3.1	83	

Planner Student Desk Leg Color Choice



Planner Student Desk Standard Laminate Color Choice



Planner Student Standard Edge Color Choice



Planner Desks Have Top and Edge Choices

1 1/4" TOP

CHOICE 1 - 3/4" Bumper T-Mold

CHOICE 2 - 3mm Edge

CHOICE 3 - 3mm T-Mold

3/4" TOP

CHOICE 4 - 3mm Edge

CHOICE 5 - 3mm T-Mold

CHOICE 6 - Bullet T-Mold

CHOICE 1 - 1 1/4" top with Bumper T-Mold no letter to follow Model No.

CHOICE 2 - 1 1/4" top with 3mm Edge **F** to follow Model No.

CHOICE 3 - 1 1/4" top with 3mm T-Mold **H** to follow Model No.

CHOICE 4 - 3/4" top with 3mm Edge **E** to follow Model No.

CHOICE 5 - 3/4" top with 3mm T-Mold **G** to follow Model No.

CHOICE 6 - 3/4" top with Bullet T-Mold **V** to follow Model No.

PLANNER™ Three-Student Desk



20" deep Planner Three-Student Desk Model 01295
Shown in Fusion Maple top with Persian Blue edge and Platinum frame. Shown with optional Flavors Chairs in Persian Blue.

20" and 24" deep models

Model	Description	D"	W"	H"	F.C.	Cube	Wt.	UPS
01295	Planner Student Desk Three-Student	20	84	22-32	70	2.9	86	
01296	Planner Student Desk Three-Student	24	84	22-32	70	2.9	98	



Desk Fence

Create carrel applications for peer work or individual study in libraries or labs with our Desk Fence. It filters light and defines workstations, yet keeps the area open and visible. Combine Desk Fences with an I-O Post to create powered workstations. Screw or clamp down to most tops. Choose from 20 standard colors. Pole and frame are Platinum.

Model	Description	D"	W"	H"	F.C.	Cube	Wt.	UPS
DF24	24" wide Desk Fence	2	24	14	70	0.75	4	*
DF30	30" wide Desk Fence	2	30	14	70	1.0	6	*
DF36	36" wide Desk Fence	2	36	14	70	1.25	8	*
DF48	48" wide Desk Fence	2	48	14	70	1.5	10	
DF60	60" wide Desk Fence	2	60	14	70	2.0	12	
DF72	72" wide Desk Fence	2	72	14	70	2.5	14	
DF84	84" wide Desk Fence	2	84	14	70	3.0	16	
DF90	90" wide Desk Fence	2	90	14	70	3.5	18	



NEW PRESENTup White Board

Leave it to Smith System to transform dry-erase boards into a practical teaching tool for real-world classrooms. PresentUp Student Whiteboard System is a comprehensive solution that teams the whiteboards with a versatile mounting system and all-in-one device for organizing, storing and transporting them.

- A clip mounted on the underside of the work surface holds the board securely in place and out of the way.
- Dry-erase surfaces on both sides.
- Rugged, ergonomic polypropylene frame has rounded corners and no sharp edges.

See pages 144-147 for more information

Model	Description	D"	W"	H"	F.C.	Cube	Wt.	UPS
PU17700PLT	PRESENTup White Board Assembly - Non-Magnetic	18	22	1.5	70	0.5	3.5	*
PU17001PLT	PRESENTup White Board Assembly - Magnetic	18	22	1.5	70	0.5	3.5	*
PU17705PLT	PRESENTup White Board Desktop Clamp-on Bracket	3	3	5	70	0.1	3.5	*
PU17706PLT	PRESENTup White Board Under Desk Clamp-on Bracket	3	3	5	70	0.1	3	*



Planner Two-Student Desks with Flavors Stack Chairs in the classroom.



UXL Power Socket Model 17083 or Model 17060 are durable and attach securely to the work surface.

Model	Description	F.C.	Cube	Wt.	UPS
17083	6ft. cord Power Socket (4 Power Plugs, 2 Data Plugs)	70		4	
17060	15ft. cord Power Socket (4 Power Plugs, 2 Data Plugs)	70		4	

Planner Student Desk Leg Color Choice



Planner Student Desk Standard Laminate Color Choice

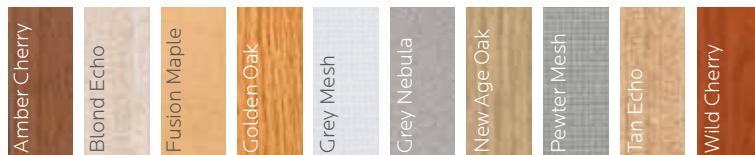

Planner Student Standard Edge Color Choice



Planner Desks Have Top and Edge Choices

1 1/4" TOP

CHOICE 1 - 3/8" Bumper T-Mold

CHOICE 2 - 3mm Edge

CHOICE 3 - 3mm T-Mold

3/4" TOP

CHOICE 4 - 3mm Edge

CHOICE 5 - 3mm T-Mold

CHOICE 6 - Bullet T-Mold

CHOICE 1 - 1 1/4" top with Bumper T-Mold no letter to follow Model No.

CHOICE 2 - 1 1/4" top with 3mm Edge **F** to follow Model No.

CHOICE 3 - 1 1/4" top with 3mm T-Mold **H** to follow Model No.

CHOICE 4 - 3/4" top with 3mm Edge **E** to follow Model No.

CHOICE 5 - 3/4" top with 3mm T-Mold **G** to follow Model No.

CHOICE 6 - 3/4" top with Bullet T-Mold **V** to follow Model No.



Cascade Storage: The 3" EW Totes can be used under selected desks; Silhouette, **Planner Rectangles**, Flexline and Arc.

Planner Student Desk Model 01272V shown with optional Tote Tray with Housing Model 30926



EW Tote Tray

Translucent EW Tote Tray interfaces with Cascade™ Storage Units that hold EW Trays. For 20 x 27 desk.

Model	Description	D"	W"	H"	F.C.	Cube	Wt.	UPS
30926	EW (Extra Wide) Tote Tray with housing	16.6	18.4	3	70	1.13	8	*



Steel Bookbox

Durable Steel Bookbox in rugged Black powder coat finish. Special order Champagne and Platinum.

Model	Description	D"	W"	H"	F.C.	Cube	Wt.	UPS
17190	Steel Book Box	15	20	4	70	3.0	8	*
17192	Steel Book Box	15	17	4	70	3.0	8	*



Wire Bookbox

Wire Bookbox in rugged Black powder coat finish.

Model	Description	D"	W"	H"	F.C.	Cube	Wt.	UPS
17200	Wire book basket	15	18	3.5	70	3.0	5	*



Planner Single-Student Desks with Intuit Stack Chairs in the classroom.



Planner Leg Casters

Add easy mobility to Planner Activity Tables and Student Desks with these casters. Choose a set of two for wheelbarrow mobility, or a set of four for level mobility.

Model	Description			F.C.	Cube	Wt.	UPS
17549	2" Caster Pack - Wheelbarrow	2 locking	Set of 2	70	0.5	4	*
17557	3" Caster Pack	2 locking	Set of 4	70	0.5	12	*



Side Bookbox / Laptop Holder

Keeps laptop or other school supplies out of the way until they are needed. Black powder coat finish. Special order Champagne and Platinum. Recommended for use on desks 36" wide or more.

Model	Description	D"	W"	H"	F.C.	Cube	Wt.	UPS
17194	Side Book Box / Laptop Holder	12	8	16	85	0.9	10	*

PLANNER™ Activity Tables



- High-pressure laminate surface resists wear.
- Choose from several edge treatments.
- Table height adjusts 24" to 34" in 1" increments, meets ADA requirements.
- 1" adjustable leveling glides provide stability on uneven floors.

Planner Rectangle Activity Table

This table offers maximum strength and stability for a wide variety of classroom uses. Three height ranges available allow you to fit the table to the grade range of the student. Choose from 10 standard laminate colors, 20 standard edge colors and four leg colors.

20" deep models

Model	Description	D"	W"	H"	F.C.	Cube	Wt.	UPS
25950	Planner Activity Table Rectangle	20	36	24-34	70	1.7	61	*
25960	Planner Activity Table Rectangle	20	48	24-34	70	2.2	72	*
25970	Planner Activity Table Rectangle	20	60	24-34	70	2.8	80	
25980	Planner Activity Table Rectangle	20	72	24-34	70	3.3	94	
25990	Planner Activity Table Rectangle	20	90	24-34	70	4.2	108	

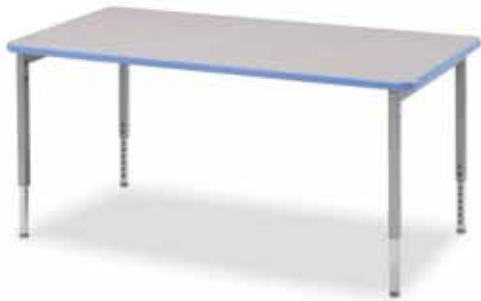

24" deep models

Model	Description	D"	W"	H"	F.C.	Cube	Wt.	UPS
25800	Planner Activity Table Rectangle	24	36	24-34	70	2.0	67	*
25810	Planner Activity Table Rectangle	24	48	24-34	70	2.6	80	*
25820	Planner Activity Table Rectangle	24	60	24-34	70	3.3	90	
25830	Planner Activity Table Rectangle	24	72	24-34	70	4.0	105	
25840	Planner Activity Table Rectangle	24	90	24-34	70	5.0	122	



30" deep models

Model	Description	D"	W"	H"	F.C.	Cube	Wt.	UPS
25500	Planner Activity Table Rectangle	30	36	24-34	70	2.5	76	*
25510	Planner Activity Table Rectangle	30	48	24-34	70	3.0	90	*
25520	Planner Activity Table Rectangle	30	60	24-34	70	3.8	104	
25530	Planner Activity Table Rectangle	30	72	24-34	70	4.5	120	
25540	Planner Activity Table Rectangle	30	90	24-34	70	6.3	137	

*Optional legs for 30" and 36" deep models:

- Low range available in 15-24"h. Add **L** following model number. Available in Black and Platinum frame only.
- Fixed-height leg available in 29.5"h. Add **X** following model number. Available in Black only.



36" deep Rectangle Planner Activity Table, Model 25570L
 Shown in New Age Oak with Mocha edge and Platinum frame, low range legs. Shown with optional Flavors Stack Chairs in Mocha, Chocolate and Cerulean.



Center support channel is 2" by 3" wide of 14-gauge steel, with 11-gauge steel endplates for maximum stability.

36" deep models

Model	Description	D"	W"	H"	F.C.	Cube	Wt.	UPS
25550	Planner Activity Table Rectangle	36	48	24-34	70	3.6	102	
25560	Planner Activity Table Rectangle	36	60	24-34	70	4.5	118	
25570	Planner Activity Table Rectangle	36	72	24-34	70	5.4	135	
25580	Planner Activity Table Rectangle	36	90	24-34	70	6.8	158	

***Optional legs for 30" and 36" deep models:**

- Low range available in 15"-24"h. Add **L** following model number. Available in Black and Platinum frame only.
- Fixed-height leg available in 29.5"h. Add **X** following model number. Available in Black only.



Planner Table - Short Adjustable Leg

Designed for Early Childhood use, this option allows height adjustability from 15"-24" in 1" increments, features 1" leveling glides. Available on select Planner. Add **L** following model number. Black and Platinum frame only.



Planner Table - High Leg Inserts For 20", 24" and 30" deep tables only.

Order special lower leg insert set for adjustment from 30¹/₄" to 40¹/₄" high. 4 pack Model 17500



Planner Table - Fixed Height Leg

Set at 29 1/2", features 1" leveling glides to assure a steady table on uneven floors. Available on select Planner models. Black only. Add **X** following model number.

PLANNER™ Activity Tables



- High-pressure laminate surface resists wear.
- Choose from several edge treatments.
- Table height adjusts 24" to 34" in 1" increments, meets ADA requirements.
- 1" adjustable leveling glides provide stability on uneven floors.

Planner Rectangle Activity Table

This table offers maximum strength and stability for a wide variety of classroom uses. Three height ranges available allow you to fit the table to the grade range of the student. Choose from 10 standard laminate colors, 20 standard edge colors and four leg colors.

42" deep models

Model	Description		D"	W"	H"	F.C.	Cube	Wt.	UPS
25590	Planner Activity Table	Rectangle	42	90	24-34	70	8.75	195	
25700	Planner Activity Table	Rectangle	42	60	24-34	70	5.8	143	
25710	Planner Activity Table	Rectangle	42	72	24-34	70	7.0	163	



48" deep models

Model	Description		D"	W"	H"	F.C.	Cube	Wt.	UPS
25720	Planner Activity Table	Rectangle	48	60	24-34	70	6.7	159	
25730	Planner Activity Table	Rectangle	48	72	24-34	70	8.0	181	
25740	Planner Activity Table	Rectangle	48	90	24-34	70	10.0	215	



Drawer Cabinets

Individually locking 2" drawers run full depth for maximum space.
Color Choices: Black or Champagne.

Model	Description		D"	W"	H"	F.C.	Cube	Wt.	UPS
09350	6 Drawer Cabinet		21.5	15.5	22	125	5.4	54	
09450	12 Drawer Cabinet		21.5	15.5	39	125	9.0	90	

F 1 1/4" Top
3mm Edge
(Rectangle only)

H 1 1/4" Top
3mm T-Mold

1 1/4" Top
Bumper T-Mold

G 3/4" Top
3mm T-Mold

V 3/4" Top
Bullet T-Mold

E 3/4" Top
3mm Edge
(Rectangle only)



Tops, Edges,
T-Molds,
Bumper T-Molds and
Bullet T-Molds

Planner Table Frame Color Choice

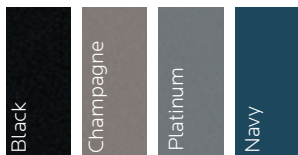

Planner Table Standard Laminate Color Choice

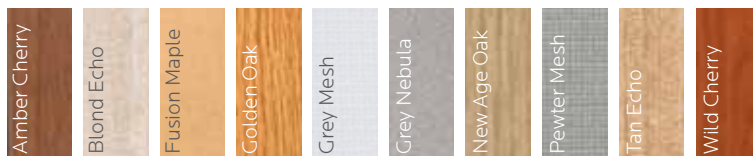

Planner Table Standard Edge Color Choice

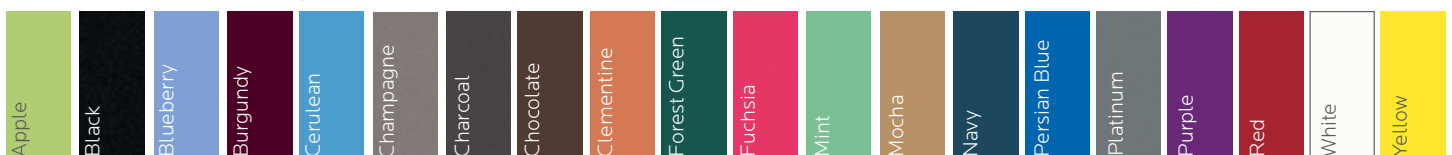

Planner Tables Have Top and Edge Choices

1 1/4" TOP

CHOICE 1 3/8" Bumper T-Mold

F 3mm Edge

CHOICE 2 3mm T-Mold

H 3mm T-Mold

CHOICE 3

3/4" TOP

E 3mm Edge

CHOICE 4 3mm T-Mold

G 3mm T-Mold

CHOICE 5 Bullet T-Mold

V Bullet T-Mold

CHOICE 6

CHOICE 1 - 1 1/4" top with Bumper T-Mold no letter to follow Model No.

CHOICE 2 - 1 1/4" top with 3mm Edge **F** to follow Model No. *Rectangle only.*

CHOICE 3 - 1 1/4" top with 3mm T-Mold **H** to follow Model No.

CHOICE 4 - 3/4" top with 3mm Edge **E** to follow Model No. *Rectangle only.*

CHOICE 5 - 3/4" top with 3mm T-Mold **G** to follow Model No.

CHOICE 6 - 3/4" top with Bullet T-Mold **V** to follow Model No.

PLANNER™ Activity Tables

- High-pressure laminate surface resists wear.
- Choose from several edge treatments.
- Table height adjusts 24" to 34" in 1" increments, meets ADA requirements.
- 1" adjustable leveling glides provide stability on uneven floors.



Planner Trapezoid Activity Table

This versatile table offers maximum strength and stability. For group work, combine two to make a hexagon or four to make an open square. Three height ranges available allow you to fit the table to the grade range of the student. Choose from 10 standard laminate colors, 20 standard edge colors and four leg colors.

- Low range available in 15-24"h. Add L following model number.
- Fixed-height leg available in 29.5"h. Add X following model number. Available in Black only.

Model	Description	D"	W"	H"	F.C.	Cube	Wt.	UPS
25600	Planner Activity Table Trapezoid	30	60	24-34	70	3.8	90	



Planner Square Activity Table

This table offers maximum strength and stability for a wide variety of classroom uses. Three height ranges available allow you to fit the table to the grade range of the student. Choose from 10 standard laminate colors, 20 standard edge colors and four leg colors.

Model	Description	D"	W"	H"	F.C.	Cube	Wt.	UPS
25610	Planner Activity Table Square	48	48	24-34	70	4.8	133	



Planner Round Activity Table

This table encourages interaction and offers maximum strength and stability. Three height ranges available allow you to fit the table to the grade range of the student. Choose from 10 standard laminate colors, 20 standard edge colors and four leg colors.

Model	Description	D"	W"	H"	F.C.	Cube	Wt.	UPS
25620	Planner Activity Table Round	42" diameter		24-34	70	3.7	86	
25630	Planner Activity Table Round	48" diameter		24-34	70	4.8	98	
25640	Planner Activity Table Round	60" diameter		24-34	70	7.5	148	



Planner Half Moon Activity Table

This table is perfect for small group instruction and offers maximum strength and stability. Three height ranges available allow you to fit the table to the grade range of the student. Choose from 10 standard laminate colors, 20 standard edge colors and four leg colors.

Model	Description	D"	W"	H"	F.C.	Cube	Wt.	UPS
25650	Planner Activity Table Half Moon	36	72	24-34	70	5.25	102	

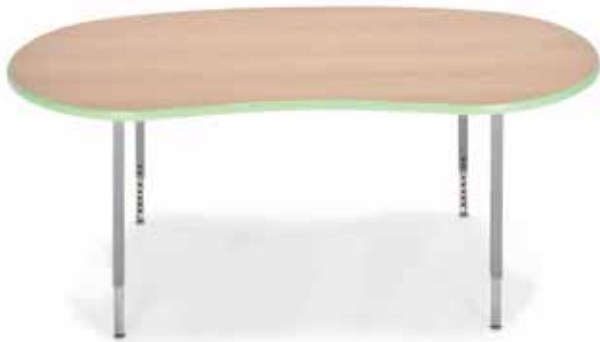

Planner Contour Activity Table

Great for small group instruction and interaction, this table offers maximum strength and stability. Three height ranges available allow you to fit the table to the grade range of the student. Choose from 10 standard laminate colors, 20 standard edge colors and four leg colors.

Model	Description	D"	W"	H"	F.C.	Cube	Wt.	UPS
25660	Planner Activity Table Contour	36	72	24-34	70	5.25	128	
25665	Planner Activity Table Kidney	48	72	24-34	70	7.0	149	
25900	Conference Table Boat Shape	48	96	24-34	70	9.3	225	



Interchange™ and Planner Rectangle Modesty Panel

Designed to complement tables in the Interchange and Planner lines. Order it in any of 10 standard laminate colors, 20 edge colors.

Model	Description	D"	W"	H"	F.C.	Cube	Wt.	UPS
17201	Modesty Panel for 36" wide table				70		18	*
17202	Modesty Panel for 48" wide table				70		24	*
17203	Modesty Panel for 60" wide table				70		30	*
17204	Modesty Panel for 72" wide table				70		36	
17205	Modesty Panel for 90" wide table				70		44	

Planner Table Frame Color Choice



Planner Table Standard Laminate Color Choice



Planner Table Standard Edge Color Choice

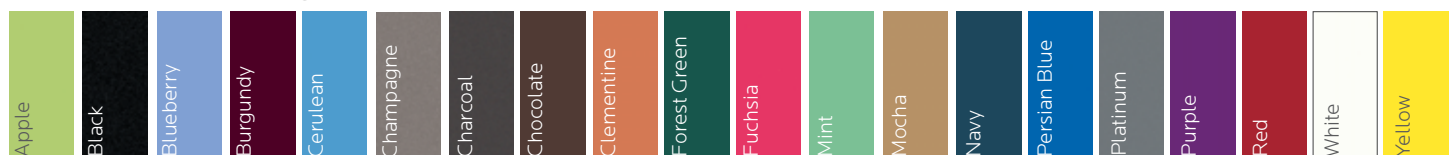

Planner Tables Have Top and Edge Choices

1 1/4" TOP

CHOICE 1 - 1 1/4" top with Bumper T-Mold no letter to follow Model No.

CHOICE 2 - not available

CHOICE 3 - 1 1/4" top with 3mm T-Mold H to follow Model No.

CHOICE 4 - not available

3/4" TOP

CHOICE 5 - 3/4" top with 3mm T-Mold G to follow Model No.

CHOICE 6 - 3/4" top with Bullet T-Mold V to follow Model No.

PLANNER™ Science & Art Tables

Choose a durable high-pressure laminate top or Trespa TopLab Plus top that offers excellent chemical resistance.



Planner Science Table with Laminate Top

1 1/4" thick with vinyl edge band. Choose frame, top and edge colors from color chart below. Graphite Nebula laminate tabletop color also available.

- Supports up to 400 lbs.
- Table height adjusts 24" to 34" in 1" increments, meets ADA requirements.
- 1" adjustable leveling glides provide stability on uneven floors.

Model	Description	D"	W"	H"	F.C.	Cube	Wt.	UPS
11260	Planner Science Table	24	48	24-34	70	2.3	85	
11263	Planner Science Table	24	54	24-34	70	2.6	90	
11266	Planner Science Table	24	60	24-34	70	2.9	95	
11269	Planner Science Table	24	72	24-34	70	3.5	110	



Trespa™ TopLab™ Plus Planner Table

This science table combines maximum strength, stability and durability. Its Trespa TopLab Plus work surface is designed for maximum durability and provides ample space for projects of all kinds.

- Supports up to 400 lbs.
- Table height adjusts 24" to 34" in 1" increments, meets ADA requirements.
- 1" adjustable leveling glides provide stability on uneven floors.
- Color Choices: Black or Grey top; Black edge (standard); Platinum or Black frame.

Model	Description	D"	W"	H"	F.C.	Cube	Wt.	UPS
24" deep								
11262	Trespa™ TopLab™ Plus Planner Science Table	24	48	24-34	70	2.3	112	
11265	Trespa™ TopLab™ Plus Planner Science Table	24	54	24-34	70	2.6	122	
11268	Trespa™ TopLab™ Plus Planner Science Table	24	60	24-34	70	2.9	130	
11271	Trespa™ TopLab™ Plus Planner Science Table	24	72	24-34	70	3.5	152	
30" deep								
11288	Trespa™ TopLab™ Plus Planner Science Table	30	60	24-34	70	3.5	152	



Trespa™ TopLab™ Plus Planner Science Table Model 25715
Shown in Grey Trespa TopLab Plus and Platinum frame.
Shown with optional UXL™ Stack Chairs.

- Supports up to 400 lbs.
- Table height adjusts 24" to 34" in 1" increments, meets ADA requirements.
- 1" adjustable leveling glides provide stability on uneven floors.

Model	Description	D"	W"	H"	F.C.	Cube	Wt.	UPS
42" deep								
25705	Trespa™ TopLab™ Plus Planner Science Table	42	60	22-34	70	5.0	180	
25715	Trespa™ TopLab™ Plus Planner Science Table	42	72	22-34	70	6.0	202	
48" deep								
25725	Trespa™ TopLab™ Plus Planner Science Table	48	60	22-34	70	5.8	240	
25735	Trespa™ TopLab™ Plus Planner Science Table	48	72	22-34	70	7.0	284	



Square Café Table Tops

Provides stability and easy ingress and egress. Choose from three sizes, 10 standard laminate colors, and 20 standard edge colors. Order base (in sitting or standing height) separately. 1 1/4" thick top with Bumper T-Mold (standard) or 3mm T-Mold edge (option H).

Shown on 29" high Platinum base.

Shown in Grey Nebula top with Blueberry edge. Optional Intuit Sled Base Chairs, Model 00520.

Model	Description	D"	W"	H"	F.C.	Cube	Wt.	UPS
Square Café Table Tops								
01501	Square top only	30	30		70	1.5	29	*
01503	Square top only	36	36		70	2.25	42	*
01505	Square top only	42	42		70	3.0	57	*



Round Café Table Tops

Provides stability and easy ingress and egress. Choose from four sizes, 10 standard laminate colors, and 20 standard edge colors. Order base (in sitting or standing height) separately. 1 1/4" thick top with Bumper T-Mold (standard) or 3mm T-Mold edge (option H).

Shown on 42" high Platinum base.

Shown in Grey Mesh top with Yellow edge. Optional Flavors Stools, Model 11890.

Model	Description	D"	W"	H"	F.C.	Cube	Wt.	UPS
Round Café Table Tops								
01502	Round top only	30" diameter			70	1.5	25	*
01504	Round top only	36" diameter			70	2.25	33	*
01506	Round top only	42" diameter			70	3.0	45	*
01507	Round top only	48" diameter			70	4.0	58	

Café Table Base Options

01525	4 point Base 28" diameter - sitting height			29	70	1.0	34	
01536	4 point Base 28" diameter - standing height			42	70	1.0	38	

Base color choice: Black, Champagne or Platinum

Planner Table Frame Color Choice



Planner Table Standard Laminate Color Choice

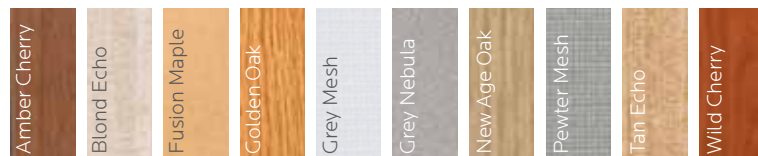

Planner Table Standard Edge Color Choice



Planner Tables Have Top and Edge Choices

CHOICE 1 - 1 1/4" top with Bumper T-Mold
no letter to follow Model No.

CHOICE 2 - not available

CHOICE 3 - 1 1/4" top with 3mm T-Mold
H to follow Model No.

CHOICE 4 - not available

CHOICE 5 - 3/4" top with 3mm T-Mold
G to follow Model No.

CHOICE 6 - 3/4" top with Bullet T-Mold
V to follow Model No.

PLANNER™ Lab Station



Planner Lab Station Model 24510
Shown in Grey Nebula top with Navy edge and Navy frame. Shown with optional Flat Panel Monitor Mount, Model 17350.

Planner Lab, One- and Two-Student

Provides maximum strength and stability. Keeps cables and wires tucked neatly away with an integral Wire Manager. Comes with handy backpack pegs. Choose from 10 standard laminate colors, 20 standard edge colors and four frame colors.

- Available in multiple lengths and widths, allowing you to create workstations for one, two and three students.
- 1 1/4" thick top with high pressure laminate surface and 3/8" thick bumper edge molding stapled every 8".
- Cord cutout at rear of work surface. 8" high x 3" deep wire manager of 16-gauge steel with cable ports.

24" deep models

Model	Description	D"	W"	H"	F.C.	Cube	Wt.	UPS
24610	Planner Lab Station One-student	24	36	22-32	70	1.8	56	*
24500	Planner Lab Station Two-student	24	48	22-32	70	2.4	68	*
24510	Planner Lab Station Two-student	24	60	22-32	70	3.0	80	
24520	Planner Lab Station Two-student	24	72	22-32	70	3.6	92	
24620	Planner Lab Station Three-student	24	84	22-32	70	4.2	104	

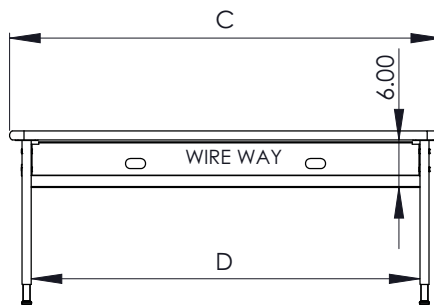
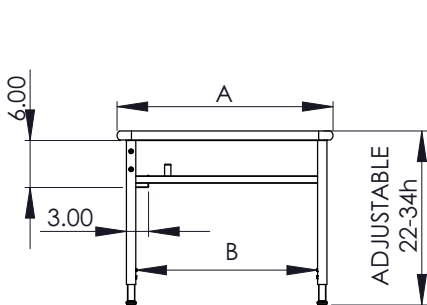

Dimension Chart (inches)				
Model	A	B	C	D
24610	24	19.24	36	30
24500	24	19.24	48	42
24510	24	19.24	60	54
24520	24	19.24	72	66
24620	24	19.24	84	78
24530	30	25.24	30	24
24630	30	25.24	60	54
24540	30	25.24	48	42
24550	30	25.24	60	54
24560	30	25.24	72	66
24570	30	25.24	84	78



Shown in Fusion Maple top with Platinum edge and Platinum frame. Shown with optional Intuit™ Sled Base Chair in Blueberry.

Planner Lab, Three Student

Provides maximum strength and stability for three students and computers. Keeps cables and wires neatly tucked away with an integral Wire Manager. Comes with handy backpack pegs. Choose from 10 standard laminate colors, 20 standard edge colors and four frame colors.

- 1 1/4" thick top with high pressure laminate surface and 3/8" thick bumper edge molding stapled every 8".
- Cord cutout at rear of work surface. 8" high x 3" deep wire manager of 16-gauge steel with cable ports.

Model	Description	D"	W"	H"	F.C.	Cube	Wt.	UPS
24620	Planner Lab Station Three-student	24	84	22-32	70	4.2	104	
24570	Planner Lab Station Three-student	30	84	22-32	70	5.5	125	



Planner Lab, Corner Station

This maximizes space utilization by allowing student to work in a corner. It provides the strength and stability that Planner Labs are known for. Cutout in desktop helps manage cables while allowing a snug fit against both walls. Choose from 10 standard laminate colors, 20 standard edge colors and four frame colors.

Model	Description	D"	W"	H"	F.C.	Cube	Wt.	UPS
24600	Corner Planner Lab Station - 6 Sided Corner	30	48	22-32	70	5.8	114	



Optimize floor space utilization with stable Planner Lab Stations, shown with optional Intuit™ Chairs in Black.



Planner Leg Casters

Add easy mobility to Planner Activity Tables and Student Desks with these casters. Choose a set of two for wheelbarrow mobility, or a set of four for level mobility.

Model	Description			F.C.	Cube	Wt.	UPS
17549	2" Caster Pack - Wheelbarrow	2 locking	Set of 2	70	0.5	4	*
17557	3" Caster Pack	2 locking	Set of 4	70	0.5	12	*

Planner Lab Standard Laminate Color Choice



Planner Lab Frame Color Choice

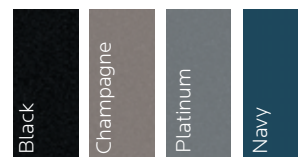

Planner Lab Standard Edge Color Choice

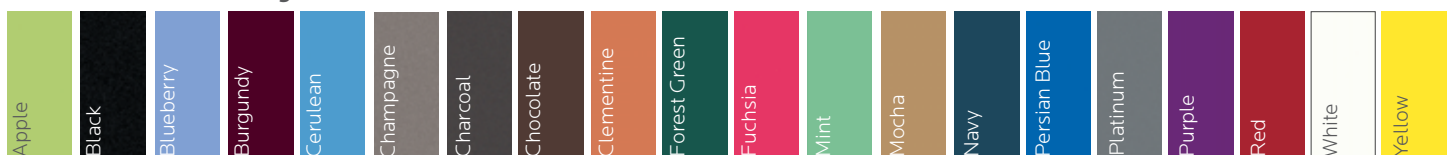

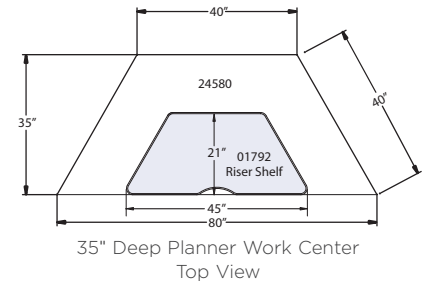
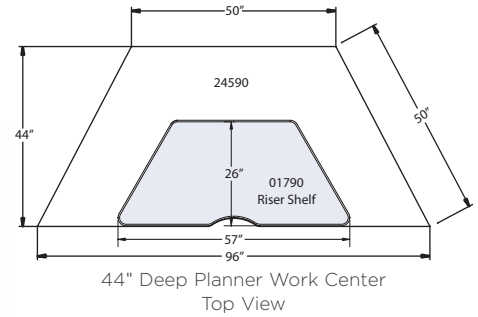

Shown in Fusion Maple top with Apple edge and Platinum frame.
Shown with optional Flavors Chairs in Apple.

Trapezoid Riser Shelves

Add to the workstation's surface to increase work space. Legs adjust in one-inch increments.



Planner Cluster Work Centers

Provides maximum strength and stability. Its semi-hexagonal shape allows three students to work in a compact space against a wall. Or put two together for a compact six-student work group. Includes a cutout in the desktop and a Wire Manager. Choose from 10 standard laminate colors, 20 standard edge colors and four frame colors.

Shown with optional Flat Panel Mounts with Tilt, Model 17350

- 1 1/4" thick top with high-pressure laminate surface and 3/8" thick bumper edge.
- Adjustable table height from 22" up to 32" in 1" increments.
- Legs of 1 1/4" square, 12-gauge steel tubes with powder coat finish.
- 1" adjustable leveling glides provide stability on uneven floors.
- Chrome-plated lower legs resist scuffing.

Model	Description	D"	W"	H"	F.C.	Cube	Wt.	UPS
24580	Cluster Work Center - Trap 40"x40"x40"x80"	35	80	22-32	70	5.4	125	
24590	Cluster Work Center - Trap 50"x50"x50"x96"	44	96	22-32	70	6.9	165	
01790	Trapezoid Riser Shelf	26	57	16-20	70	2.3	63	
01792	Trapezoid Riser Shelf	21	45	16-20	70	1.5	48	



Planner Lab Plus

Provides maximum strength and stability for students and computers. Keeps cables and wires neatly and securely tucked away in a locking Wire Manager with easy rear access. Comes with handy backpack pegs. Choose from 10 standard laminate colors and 20 standard edge colors.

Platinum frame only.

24" deep models

Model	Description	D"	W"	H"	F.C.	Cube	Wt.	UPS
24700	Planner Lab Plus	24	36	22-32	70	2.0	62	*
24710	Planner Lab Plus	24	48	22-32	70	2.7	74	*
24720	Planner Lab Plus	24	60	22-32	70	3.3	86	
24730	Planner Lab Plus	24	72	22-32	70	4.0	98	
24740	Planner Lab Plus	24	84	22-32	70	4.6	110	

30" deep models

Model	Description	D"	W"	H"	F.C.	Cube	Wt.	UPS
24745	Planner Lab Plus	30	30	22-32	70	2.1	65	
24750	Planner Lab Plus	30	36	22-32	70	2.5	71	
24760	Planner Lab Plus	30	48	22-32	70	3.3	86	
24770	Planner Lab Plus	30	60	22-32	70	4.2	101	
24780	Planner Lab Plus	30	72	22-32	70	5.0	116	
24790	Planner Lab Plus	30	84	22-32	70	5.83	130	
24800	Planner Lab Plus Corner - 6 sided, 30" corner	30	48	22-32	70	5.8	119	

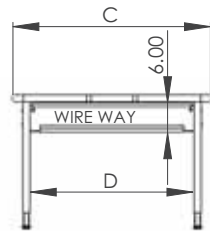
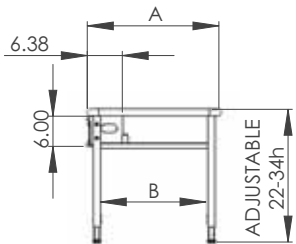

Dimension Chart (inches)				
Model	A	B	C	D
24700	24	19.24	36	30
24710	24	19.24	48	42
24720	24	19.24	60	54
24730	24	19.24	72	66
24740	24	19.24	84	78

Dimension Chart (inches)				
Model	A	B	C	D
24745	30	25.24	30	24
24750	30	25.24	60	54
24760	30	25.24	48	42
24770	30	25.24	60	54
24780	30	25.24	72	66
24790	30	25.24	84	78

Planner Lab Standard Laminate Color Choice



Planner Lab Frame Color Choice

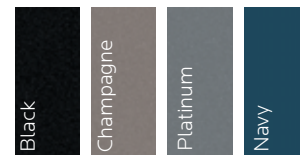

Planner Lab Standard Edge Color Choice



PLANNER™ Access Station



Model 11144. Shown in Fusion Maple top with Blueberry edge and Platinum frame. Shown with optional CPU Holder, Model 17213 and 3" Casters - set of four, Model 17557



Lift-up door on Wire Manager with key lock

Keeps wires tucked away neatly, standard lock ensures they stay that way.

Access Station, Single-Student

Provides maximum strength and stability for computer work, plus great security for cables and wires thanks to a locking Wire Manager. Comes with handy backpack peg. Choose from 10 standard laminate colors, 20 standard edge colors and four frame colors.

- Chrome-plated lower legs resist scuffing.
- 1" adjustable leveling glides provide stability on uneven floors.
- Adjustable table height from 22" up to 32" in 1" increments.
- Full-length locking 6" deep door has cord cutouts, providing easy access to wires.

24" deep models

Model	Description		D"	W"	H"	F.C.	Cube	Wt.	UPS
11140	Access Station	Single-student	24	30	22-32	70	3.5	56	*
11141	Access Station	Single-student	24	36	22-32	70	4.25	63	*
11142	Access Station	Single-student	24	42	22-32	70	5.0	70	
11143	Access Station	Two-student	24	48	22-32	70	5.7	76	
11144	Access Station	Two-student	24	60	22-32	70	7.0	93	
11145	Access Station	Two-student	24	72	22-32	70	8.5	110	
11146	Access Station	Three-Student	24	84	22-32	70	9.7	126	

*24" deep models will not accommodate Keyboard Trays.



CPU Holder

Heavy steel plate mounts under work surface. Adjusts 7-10" wide and 17-21" high. Locking Black steel tube holds tower in place.

Model	Description	D"	W"	H"	F.C.	Cube	Wt.	UPS
17213	CPU Holder	13	adj.	16	70	0.5	12	*
17217	CPU Holder	13	adj.	12	70		10	



Shown in Wild Cherry top with Charcoal edge and Black frame.
Shown with optional CPU Holder, Model 17213.

30" deep models

Model	Description		D"	W"	H"	F.C.	Cube	Wt.	UPS
11160	Access Station	Single-student	30	30	22-32	70	4.4	72	*
11161	Access Station	Single-student	30	36	22-32	70	5.4	79	*
11162	Access Station	Single-student	30	42	22-32	70	6.2	86	
11163	Access Station	Two-student	30	48	22-32	70	7.0	92	
11164	Access Station	Two-student	30	60	22-32	70	9.3	109	
11165	Access Station	Two-student	30	72	22-32	70	8.8	126	
11166	Access Station	Three-Student	30	84	22-32	70	12.0	142	



Adjustable Keyboard Shelf

Features 6" height adjustment with 10° tilt and 180° swivel with easy single control. 11"d x 25"w steel tray has padded palm rest.

Model	Description		D"	W"	H"	F.C.	Cube	Wt.	UPS
17620	Pull-out Keyboard	adjustable height	17	25	6	70	1.3	20	*
17622	Pull-out Keyboard	adjustable height	17	20	6	70		20	*

Access Stations Have Top and Edge Choices

1 1/4" TOP

3/8" Bumper T-Mold
CHOICE 1

CHOICE 1 - 1 1/4" top with Bumper T-Mold
no letter to follow Model No.

3mm T-Mold
CHOICE 3

CHOICE 3 - 1 1/4" top with 3mm T-Mold
H to follow Model No.

Access Station Standard Laminate Color Choice



Access Station Frame Color Choice

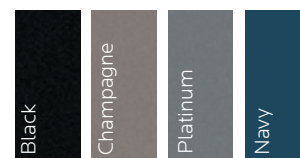

Access Station Desk Standard Edge Color Choice

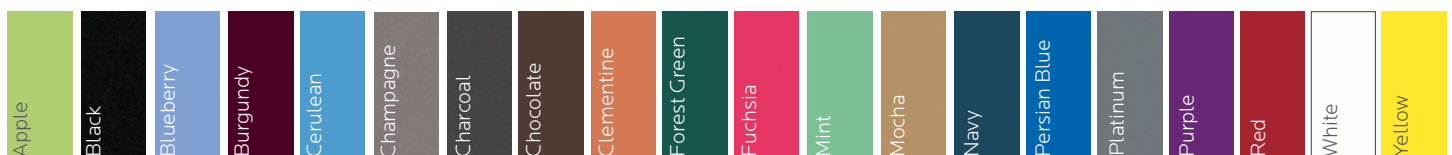

PLANNER™ Access Station



Shown in Grey Nebula top with Clementine edge and Champagne frame. Shown with optional Intuit Stack Chair, Model 00560.

Access Station, Three-Student

Provides maximum strength and stability for three students and computers, plus great security for cables and wires thanks to a locking Wire Manager. Comes with handy backpack pegs. Choose from 10 standard laminate colors, 20 standard edge colors and four frame colors. Three-Student Desks will not accommodate 3 CPU Holders.

- Chrome-plated lower legs resist scuffing.
- 1" adjustable leveling glides provide stability on uneven floors.
- Adjustable table height from 22" up to 32" in 1" increments.
- Full-length locking 6" deep door has cord cutouts, providing easy access to wires.

Model	Description		D"	W"	H"	F.C.	Cube	Wt.	UPS
24" deep									
11146	Access Station Three-Student		24	84	22-32	70	9.7	126	
30" deep									
11166	Access Station Three-Student		30	84	22-32	70	12.0	142	



Model 17081



Model 17084



UXL Power Socket is durable and attaches securely to the work surface. Choose Model 17083 with 6 ft. long cord or Model 17060 with 15 ft. long cord.

Model	Description		D"	W"	H"	F.C.	Cube	Wt.	UPS
17081	6 Outlet Electric Strip w/ Surge, 4' Cord		3	3	12	70	0.1	4	*
17084	10 Outlet Electric Strip w/ Surge, 15' Cord		3	8	12	70	0.1	5	*
17083	6' Cord Power Socket (4 Power Plugs 2 Data Plugs)		3	10	7	70	0.01	4	*
17060	15' Cord Power Socket (4 Power Plugs 2 Data Plugs)		3	10	7	70	0.01	4	*



Access Station, 5-Sided Corner

This maximizes space utilization while providing maximum strength and stability, plus great security for cables and wires thanks to a locking Wire Manager. Choose from 10 standard laminate colors, 20 standard edge colors and four frame colors.

Shown with optional Library Adjustable Chair, Model 02791.

Model	Description		D"	W"	H"	F.C.	Cube	Wt.	UPS
24" deep									
11147	Access Station	5-Sided Corner	24	48	22-32	70	8.0	112	
30" deep									
11167	Access Station	5-Sided Corner	30	48	22-32	70	11.0	128	



Mobile Drawer Pedestal

Steel construction, drawers lock and have an interlock system that prevents accidental tipping caused by more than one drawer opening at a time. Full extension ball bearing slides allow full access to drawer contents. Black, Champagne, Navy or Platinum. With 2" dual-wheel casters.

Model	Description		D"	W"	H"	F.C.	Cube	Wt.	UPS
19172	Mobile Drawer Pedestal	File/File	15.5	22	24.5	100	5.7	50	
19173	Mobile Drawer Pedestal	Box/Box/File	15.5	22	24.5	100	5.7	50	

Access Stations Have Top and Edge Choices

1 1/4" TOP

CHOICE 1 3/8" Bumper T-Mold

CHOICE 3 3mm T-Mold

CHOICE 1 - 1 1/4" top with Bumper T-Mold
no letter to follow Model No.

CHOICE 3 - 1 1/4" top with 3mm T-Mold
H to follow Model No.

Access Station Standard Laminate Color Choice

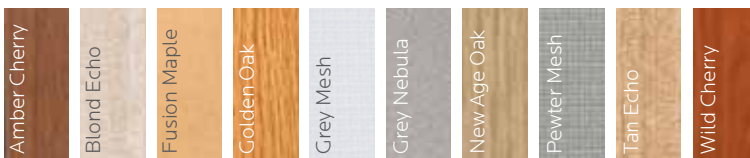

Access Station Frame Color Choice

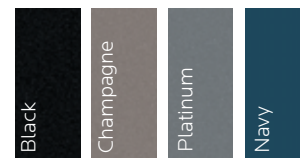

Access Station Desk Standard Edge Color Choice

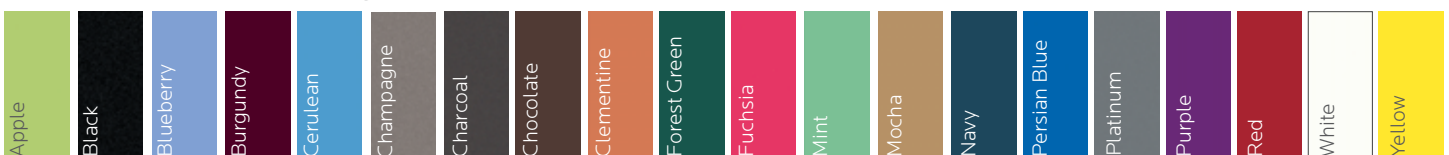

GRAPHIC™ ARTS



Shown with optional CPU Holder, Model 17213
optional Flat-Panel Monitor Mount, Model 17352
optional Intuit Adjustable Stool, Model 00541
and optional CPU Holder, Model 17213



A rugged steel
brace holds the
tilting desktop
securely in place.

CAD Desk

Split-Top work surface enables paper-and-pencil drafting and computer rendering. It features Planner™ construction for maximum strength and stability. Shown with optional Flat Panel Mount, Model 17352. Available in four color/finish combinations. Optional accessories for CAD Desk only.

- 3/4" thick top with high-pressure laminate surface and flat 3mm edge with pencil stop.
- Adjustable top slope has a range of 0 to 45 degrees.
- Adjustable table height (29"-39") accommodates stools.
- Fully box-welded leg sets of 1 3/16" x 2 1/2" 16-gauge steel tube with 1 1/4" square 14-gauge steel tube legs.

Model	Description	D"	W"	H"	F.C.	Cube	Wt.	UPS
27344	CAD Station 2 - 24 x 24 Surfaces, 1 Slope Adjustable	24	48	29-39	70	5.2	72	*

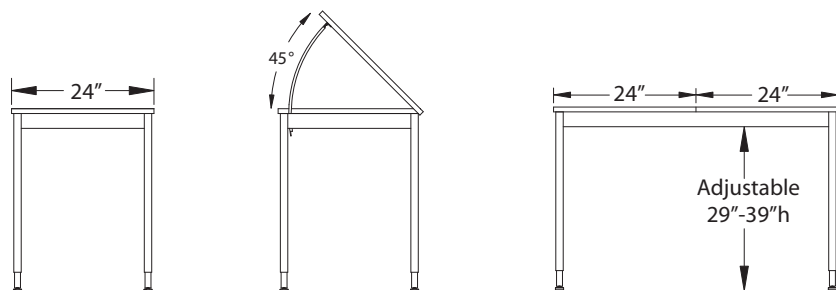



One-Piece Top Graphic Arts Tables, Model 27345. Shown in Maple top with Maple edge and Champagne frame. Shown with optional Flavors Mobile Chair, Model 11855 and 6 Drawer Cabinet, Model 09350.



Graphic Arts Table

The One-Piece Slope Top Graphic Arts Table provides a standard adjustable incline area. It features Planner™ construction for maximum strength and stability. Available in four color/finish combinations.

- 3/4" thick top with high-pressure laminate surface and flat 3mm edge with pencil stop.
- Adjustable top slope has a range of 0 to 45 degrees.
- Adjustable table height (29"-39") accommodates stools.
- Fully box-welded leg sets of 1 3/16" x 2 1/2" 16-gauge steel tube with 1 1/4" square 14-gauge steel tube legs.

Model	Description		D"	W"	H"	F.C.	Cube	Wt.	UPS
27345	Graphic Arts Table	One-Piece Top	24	36	29-39	70	3.4	62	*
27347	Graphic Arts Table	One-Piece Top	30	42	29-39	70	5.7	80	*

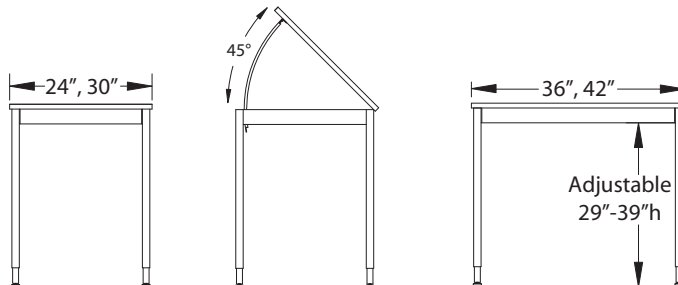



Split Top Graphic Arts Table, Model 27346. Shown in Grey top with Black edge and Black frame. Shown with optional Flavors Stool, Model 11890.



Split Top Graphic Arts Table, Model 27348. Shown in Grey top with Black edge and Black frame. Shown with optional Flavors Adjustable Stool, Model 11843 and 12 Drawer Cabinet, Model 09450.

Graphic Arts Table

The Split-Top Graphic Arts Table provides both a standard adjustable incline area and a flat work surface. It features Planner™ construction for maximum strength and stability. Available in four color/finish combinations.

- 3/4" thick top with high-pressure laminate surface and flat 3mm edge with pencil stop.
- Adjustable top slope has a range of 0 to 45 degrees.
- Adjustable table height (29"-39") accommodates stools.
- Fully box-welded leg sets of 1 3/16" x 2 1/2" 16-gauge steel tube with 1 1/4" square 14-gauge steel tube legs.

Model	Description		D"	W"	H"	F.C.	Cube	Wt.	UPS
27346	Graphic Arts Table	Split Top	24	36	29-39	70	3.4	62	*
27348	Graphic Arts Table	Split Top	30	42	29-39	70	5.7	80	*

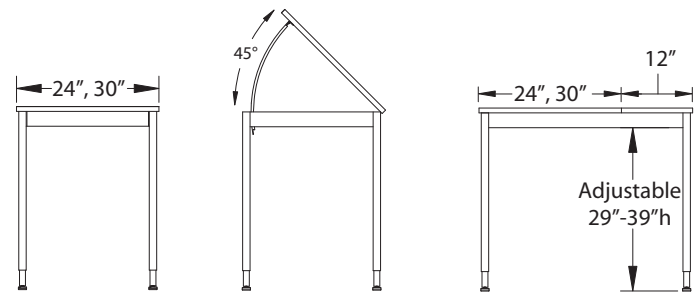

Graphic Arts Desk Top Color Choice



Graphic Arts Edge Color Choice



Graphic Arts Frame Color Choice

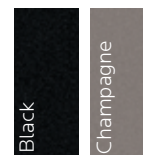

PLANNER™ Accessories



CPU Holder

Heavy steel plate mounts under work surface. Adjusts 7-10" wide and 17-21" high. Black steel tube frame with locks to hold tower in place.

Model	Description	D"	W"	H"	F.C.	Cube	Wt.	UPS
17213	CPU Holder	13	7	16	70	0.5	12	*
17217	CPU Holder	6	14	12	70		10	



Pole Leg Riser Shelf

Clamp-On Pole (Platinum only). 1 1/4" Top available in 10 standard laminate colors and 20 standard edge colors to match Planner Lab.

Model	Description	D"	W"	H"	F.C.	Cube	Wt.	UPS
17665	Riser Shelf	12	24	12	70	0.5	26	*
17666	Riser Shelf	12	30	12	70	0.6	29	*
17667	Riser Shelf	12	36	12	70	0.75	34	*
17668	Riser Shelf	12	48	12	70	1.0	45	*
17669	Riser Shelf	12	60	12	70	1.25	51	
17677	Riser Shelf	12	72	12	70	1.5	73	
17679	Riser Shelf	12	84	12	70	1.75	94	
17680	Riser Shelf	12	90	12	07	1.9	106	



Desk Fence

Create carrel applications for peer work or individual study in libraries or labs with our new Desk Fence. It filters light and defines workstations, yet keeps the area open and visible. Combine Desk Fences with an I-O Post to create powered workstations. Screw or clamp down to most tops. Choose from 20 standard colors. Pole and frame are Platinum.

Model	Description	D"	W"	H"	F.C.	Cube	Wt.	UPS
DF24	24" wide Desk Fence	2	24	14	70	0.75	4	*
DF30	30" wide Desk Fence	2	30	14	70	1.0	6	*
DF36	36" wide Desk Fence	2	36	14	70	1.25	8	*
DF48	48" wide Desk Fence	2	48	14	70	1.5	10	
DF60	60" wide Desk Fence	2	60	14	70	2.0	12	
DF72	72" wide Desk Fence	2	72	14	70	2.5	14	
DF84	84" wide Desk Fence	2	84	14	70	3.0	16	
DF90	90" wide Desk Fence	2	90	14	70	3.5	18	



Side Bookbox / Laptop Holder

Keeps laptop or other school supplies out of the way until they are needed. Black powder coat finish. Special order Champagne and Platinum. Recommended for use on desks 36" wide or more.

Model	Description	D"	W"	H"	F.C.	Cube	Wt.	UPS
17194	Side Book Box / Laptop Holder	12	8	16	85	0.9	10	*